

FERRITE CORES
2013 CATALOG

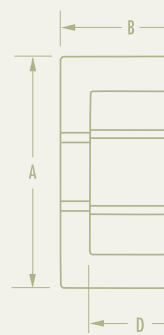
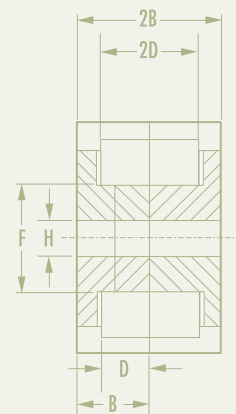
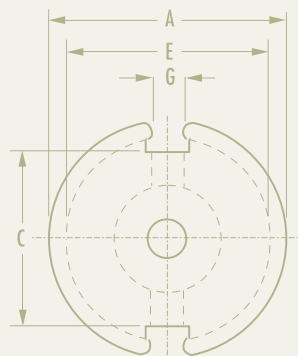

Part Number Index

TOROIDS

TOROID	PG	TOROID	PG
40200TC	16	43610TC	20
40301TC	16	43615TC	20
40401TC	16	43620TC	20
40402TC	16	43806TC	20
40502TC	16	43813TC	20
40503TC	16	43825TC	20
40601TC	16	44015TC	20
40603TC	16	44416TC	20
40705TC	16	44419TC	20
40907TC	16	44715TC	20
41003TC	16	44916TC	22
41005TC	16	44920TC	22
41206TC	16	44925TC	22
41303TC	16	44932TC	22
41304TC	16	46013TC	22
41305TC	16	46019TC	22
41306TC	16	46113TC	22
41405TC	18	46325TC	22
41406TC	18	46326TC	22
41407TC	18	47313TC	22
41410TC	18	47325TC	22
41435TC	18	48613TC	22
41450TC	18	48625TC	22
41506TC	18	48626TC	22
41605TC	18	49715TC	22
41610TC	18	49718TC	22
41809TC	18	49725TC	22
42106TC	18	49740TC	22
42109TC	18		
42206TC	18		
42207TC	18		
42212TC	18		
42507TC	18		
42508TC	18		
42712TC	20		
42908TC	20		
42915TC	20		
43113TC	20		
43205TC	20		

E CORES

E, I	PG	PLANAR E, I	PG	EC	PG
40904EC	24	41425EC	28	43517EC	38
41203EC	24	41434EC	28	44119EC	38
41205EC	24	41434IC	28	45224EC	38
41707EC	24	41805EC	28	47035EC	38
41808EC	24	41805IC	28	EER	
41810EC	24	42107EC	28	42814EC	40
42510EC	24	42107IC	28	42817EC	40
42513EC	24	42216EC	28	43521EC	40
42515EC	24	42216IC	28	44013EC	40
42515IC	24	43208EC	28	44216EC	40
42520EC	24	43208IC	28	44818EC	40
42526EC	24	43618EC	28	44821EC	40
42530EC	24	43618IC	28	45418EC	40
43007EC	24	43808EC	30	efd	
43009EC	24	43808IC	30	41009EC	42
43515EC	24	44008EC	30	41212EC	42
43520EC	24	44008IC	30	41515EC	42
44011EC	26	44308EC	30	42019EC	42
44016EC	26	44308IC	30	42523EC	42
44020EC	26	44310EC	30	43030EC	42
44020IC	26	44310IC	30	ETD	
44022EC	26	45810EC	30	42929EC	44
44033EC	26	45810IC	30	43434EC	44
44317EC	26	46410EC	30	43939EC	44
44721EC	26	46410IC	30	44444EC	44
45528EC	26	49938EC	30	44949EC	44
45530EC	26	ER		45454EC	44
45724EC	26	40906EC	32	45959EC	44
46016EC	26	41126EC	32		
46527EC	26	41308EC	32		
47133EC	26	41308IC	32		
47228EC	26	41426EC	32		
48020EC	26	41826EC	32		
49928EC	26	42014EC	32		
		42014IC	32		
		42313EC	32		
		42517EC	32		
		42521EC	32		
		43021EC	32		
		43225EC	32		

SHAPES

U, I	PG	RS-DS	PG
41106UC	34	41408UG	52
41106IC	34	41811UG	52
42220UC	34	42311UG	52
42512UC	34	42318UG	52
42515UC	34	42616UG	52
42516IC	34	43019UG	52
42530UC	34	43622UG	52
49316UC	34	44229UG	52
49316IC	34	PQ	
49330UC	34	42016UG	54
49332UC	34	42020UG	54
49920UC	34	42610UG	54
49925UC	34	42614UG	54
49925IC	34	42620UG	54
		42625UG	54
UR		43214UG	54
44119UC	36	43220UG	54
44121UC	36	43230UG	54
44125UC	36	43535UG	54
44130UC	36	44040UG	54
45716UC	36	45050UG	54
45917UC	36		
46420UC	36	RM	
BLOCK		41110UG	56
49966FB	46	41510UG	56
49985FB	46	41812UG	56
EP		41912UG	56
40707UG	48	42013UG	56
41010UG	48	42316UG	56
41313UG	48	42819UG	56
41717UG	48	43723UG	56
42120UG	48	44230UG	56
Pot			
40704UG	50		
40905UG	50		
41107UG	50		
41109UG	50		
41408UG	50		
41811UG	50		
41814UG	50		
42213UG	50		
42616UG	50		
42823UG	50		
43019UG	50		
43622UG	50		
44229UG	50		

Index

	Applications & Materials 2-11		EFD Cores..... 42-43
	Gapped Cores..... 12-15		ETD Cores 44-45
	Toroids 16-23		Block Cores..... 46-47
	E, I Cores..... 24-27		EP Cores..... 48-49
	Planar E, I Cores 28-31		Pot Cores..... 50-51
	ER Cores..... 32-33		RS/DS Cores 52-53
	U, I Cores 34-35		PQ Cores 54-55
	UR Cores 36-37		RM Cores..... 56-57
	EC Cores..... 38-39		Hardware 58
	EER Cores 40-41		Power Design 59-67

Applications & Materials



Ferrites are dense, homogenous ceramic structures made by mixing iron oxide with oxides or carbonates of one or more metals such as zinc, manganese, nickel or magnesium. They are pressed, then fired in a kiln at 1,000 - 1,500°C, and machined as needed to meet various operational requirements. Ferrite parts can be easily and economically molded into many different geometries. Many diverse materials are available, providing a choice of desirable electrical and mechanical properties.

Magnetics' ferrite cores are manufactured for a wide variety of applications. Magnetics has the leading MnZn ferrite materials for power transformers, power inductors, wide-band transformers, common mode chokes and many other applications.

ADVANTAGES OF MAGNETICS' FERRITES

- The widest range of toroid sizes in power and high permeability materials
- Superior toroid coatings available in several options: epoxy, nylon and Parylene C
- Standard gapping to precise inductance or mechanical dimension: wide range of coil former and assembly hardware available
- The full range of standard planar E and I cores
- Rapid prototyping capability for new development

FERRITE APPLICATIONS

APPLICATIONS	DESIRED PROPERTIES	PREFERRED MATERIALS	AVAILABLE SHAPES
Broadband Transformers	Low loss, high μ . Good frequency response.	J, W	Pot cores, Toroids, E, U & I cores, RM cores, EP cores
Common Mode Chokes	Very high μ (permeability).	J, W	Toroids, E Cores
Converter and Inverter Transformers	Low losses, high saturation.	F, L, P, R, T	Toroids, E, U, & I cores, Pot cores, RS cores, Planar cores
Differential Mode Inductors	Low losses, high temperature stability, good stability across load conditions.	F, P, R, T	Gapped Pot cores, EP cores, E cores, RM cores, Planar cores, PQ cores
Linear Filters and Sensors	Good loss factor, linearity and temperature linearity at low drive level.	C, E, V	Pot cores, Toroids
Narrow Band Transformers	Moderate Q, high μ , high stability.	F, J	Pot cores, Toroids, RM cores, EP cores
Noise Filters	High μ , good frequency response.	J, W	Toroids
Power Inductors	Low losses at high flux densities and temperatures. High saturation. Good stability across load conditions.	F, L, P, R, T	Pot cores, E cores, PQ cores, RM cores, Planar cores
Power Transformers	High μ and low losses at high flux densities and temperatures. High saturation. Low exciting currents.	F, L, P, R, T	Ungapped pot cores, E, U & I cores, Toroids, EP cores, RS cores, DS cores, PQ cores, Planar cores
Pulse Transformers	High μ , low loss, high B saturation.	J, W	Toroids
Telecom Inductors	Low losses, high temperature stability, good stability across load conditions.	F, P, R, T	Pot cores, EP cores, E cores, RM cores, Planar cores



			INDUCTORS & POWER TRANSFORMERS					EMI/RFI FILTERS & BROADBAND TRANSFORMERS		LINEAR FILTERS & SENSORS		
MATERIAL			L	R	P	F	T	J	W	C	E	V
Initial Permeability	μ_i		900 ± 25%	2,300 ± 25%	2,500 ± 25%	3,000 ± 20%	3,000 ± 25%	5,000 ± 20%	10,000 ± 30%	900 ± 25%	2,000 ± 25%	2,300 ± 25%
Maximum Usable Frequency (50% roll-off)	f	MHz	≤ 6	≤ 1.8	≤ 1.8	≤ 1.5	≤ 1.5	≤ 0.7	≤ 0.5	≤ 8	≤ 3	≤ 1.5
Relative Loss Factor $\times 10^{-6}$ 25°C		$\tan \delta / \mu_{oc}$						≤ 15 100 kHz	≤ 7 10 kHz	≤ 10 300 kHz	≤ 3 100 kHz	≤ 5 100 kHz
Curie Temperature	T_c	°C	> 300	> 210	> 210	> 210	> 220	> 145	> 135	> 200	> 160	> 170
Flux Density @ 1,194 A/m (15 Oe) 25°C	B_m 10 kHz	G mT	4,200 420	4,700 470	4,700 470	4,700 470	5,300 530	4,300 430	3,900 390	3,800 380	3,600 360	4,400 440
Remanence 25°C	B_r	G mT	1,500 150	1,600 160	1,600 160	1,500 150	1,500 150	1,000 100	800 80	1,500 150	700 70	1,500 150
Power Loss (PL) Sine Wave, in mW/cm ³ (typical)	25 kHz 200 mT (2,000 G)	@25°C		90	180	60	80					
		@60°C		65	110	55	75					
		@100°C		60	65	90	70					
		@120°C		65	110	125	75					
	100 kHz 100 mT (1,000 G)	@25°C		87	70	70	65					
		@60°C		64	50	65	57					
		@100°C		58	65	110	55					
		@120°C		64	45	150	58					
	500 kHz 50 mT (500 G)	@25°C	290									
		@60°C	150									
		@100°C	115	175	300		150					
		@120°C	130									
Resistivity	ρ	$\Omega \cdot m$	10	5	5	5	5	0.5	0.1	2	2	1
Density	δ	g/cm ³	4.8	4.8	4.8	4.8	4.8	4.8	4.9	4.7	4.7	4.8

R Material

A medium frequency multi-purpose power transformer, inductor and filter material. Widely available in shapes and toroids. Engineered for lowest losses between 90 - 100°C.

Initial Perm (25°C; ≤ 10 kHz) **2,300 \pm 25%**
 Saturation Flux Density (4,700 G at 15 Oe, 25°C) 470 mT, 11.9 A-T/cm
 Curie Temperature 210°C

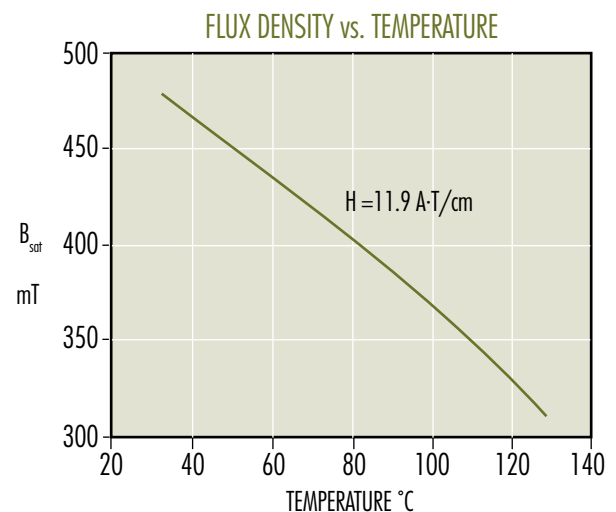
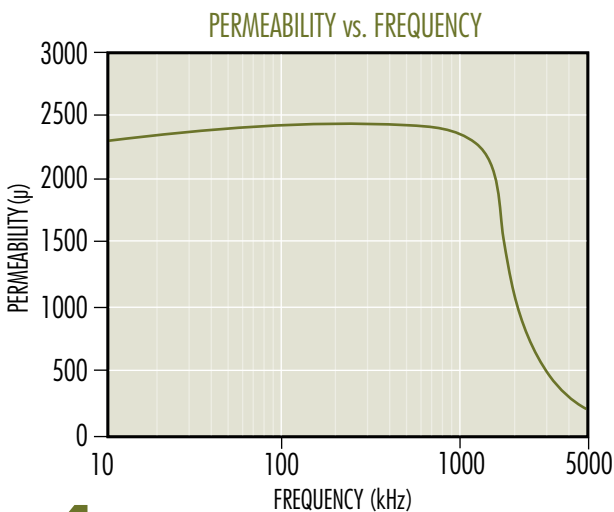
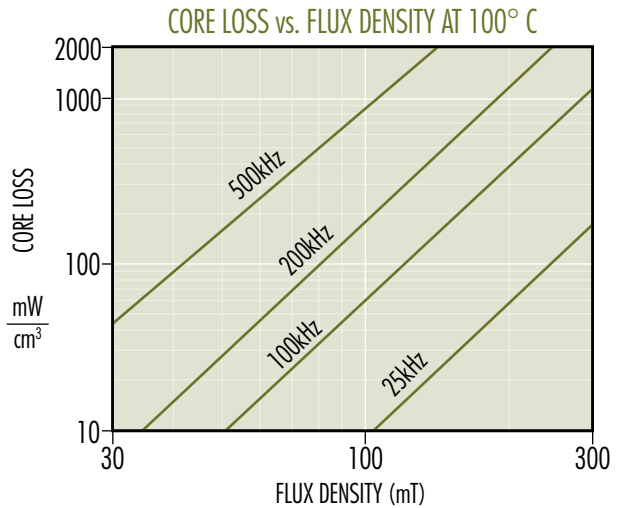
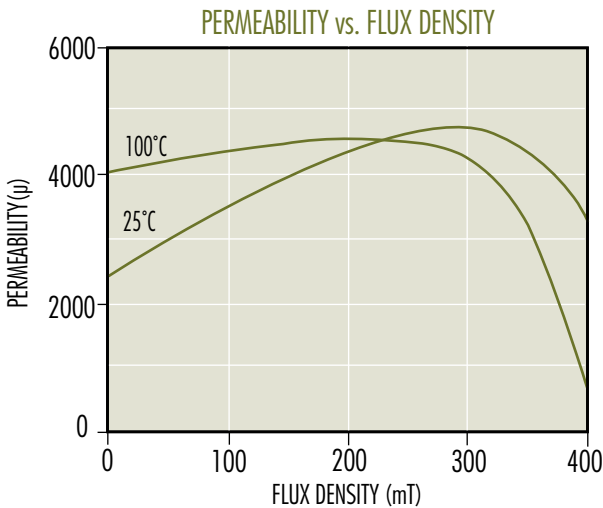
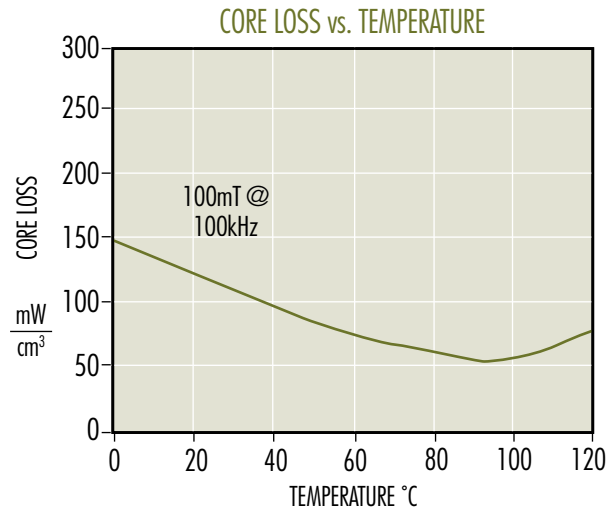
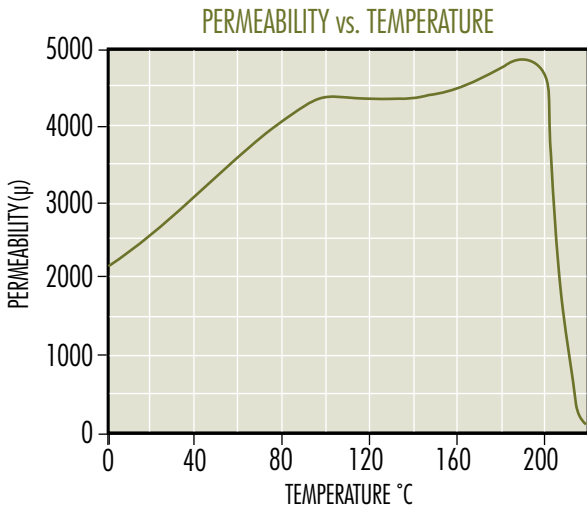

P Material

A low-medium frequency general-purpose power converter material. Engineered for lowest losses between 80 - 100°C. Available in almost all core sizes and shapes.

Initial Perm (25°C; ≤ 10 kHz) **2,500 ± 25%**
 Saturation Flux Density (4,700 G at 15 Oe, 25°C) 470 mT, 11.9 A-T/cm
 Curie Temperature 210°C

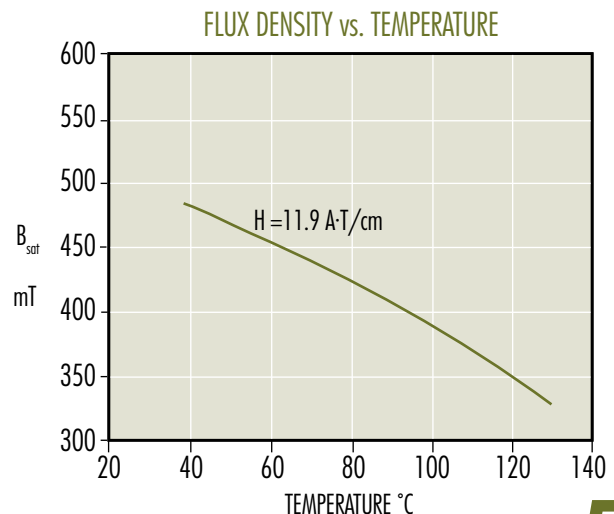
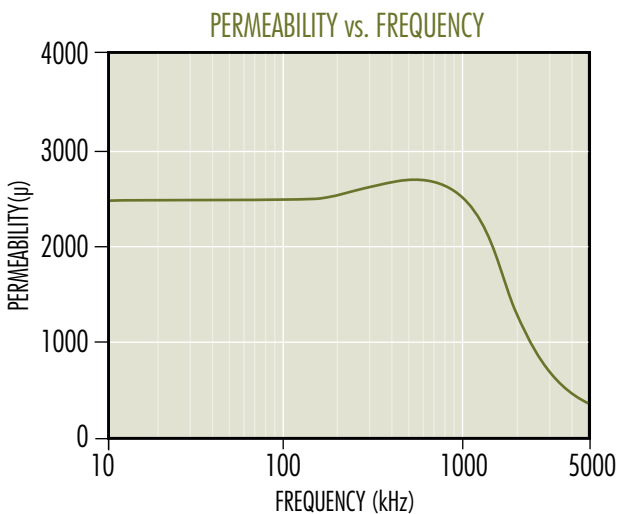
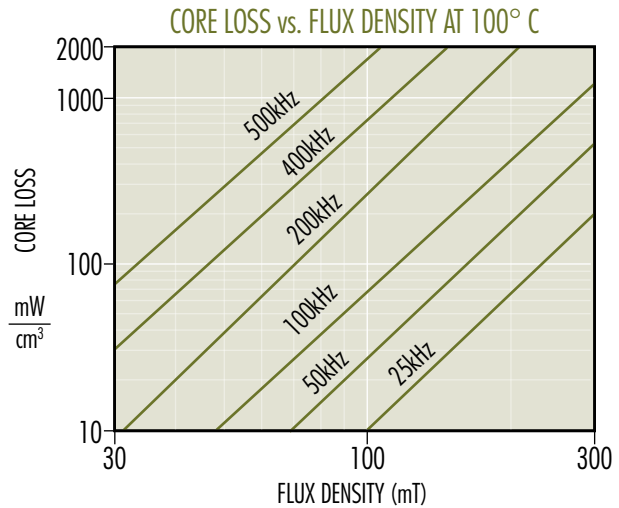
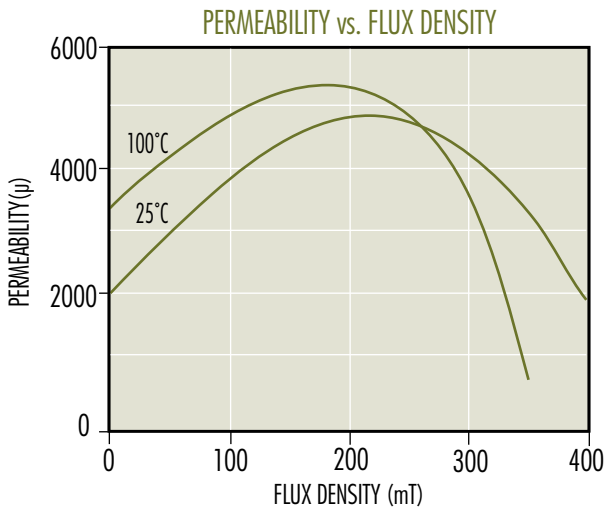
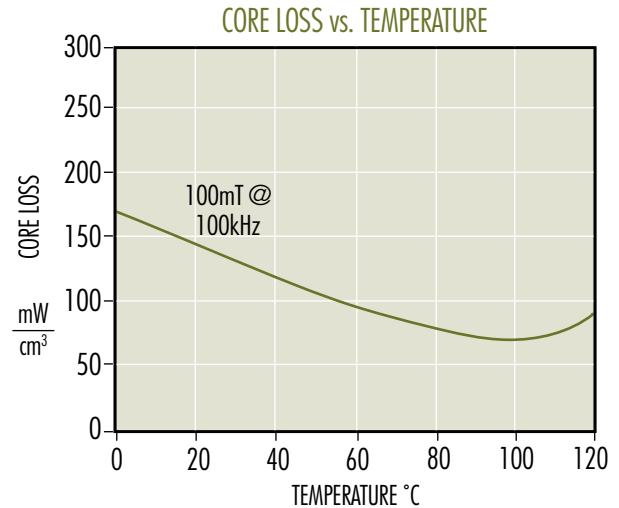
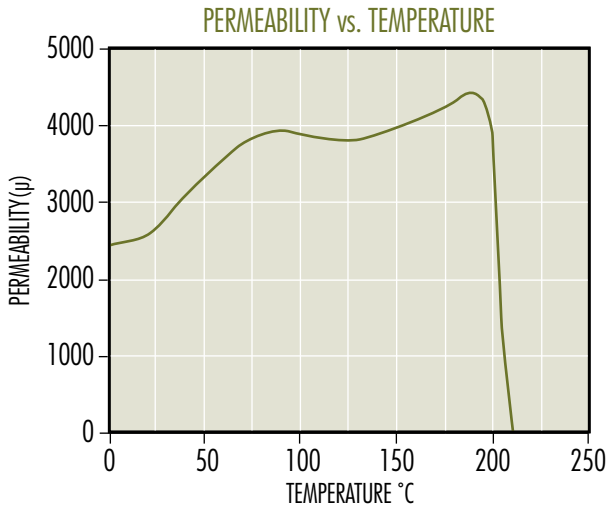

F Material

A medium frequency general-purpose power transformer, inductor and filter material. Slightly higher in perm than P or R Material. Engineered for lowest losses between 50 - 80°C.

Initial Perm (25°C; ≤10 kHz) **3,000 ± 20%**
 Saturation Flux Density (4,700 G at 15 Oe, 25°C) 470 mT, 11.9 A-T/cm
 Curie Temperature 210°C

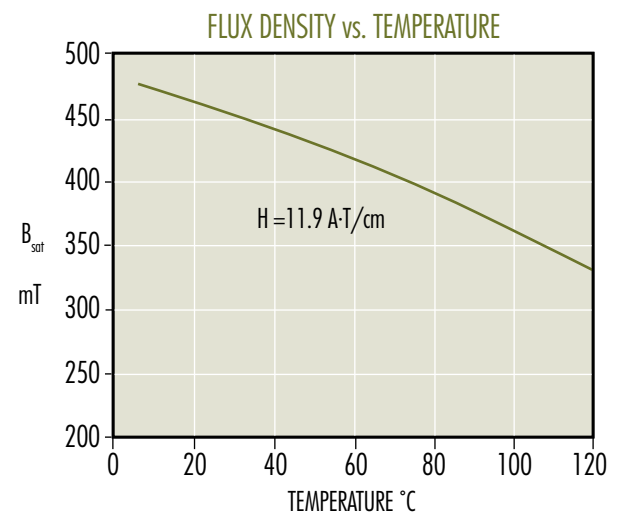
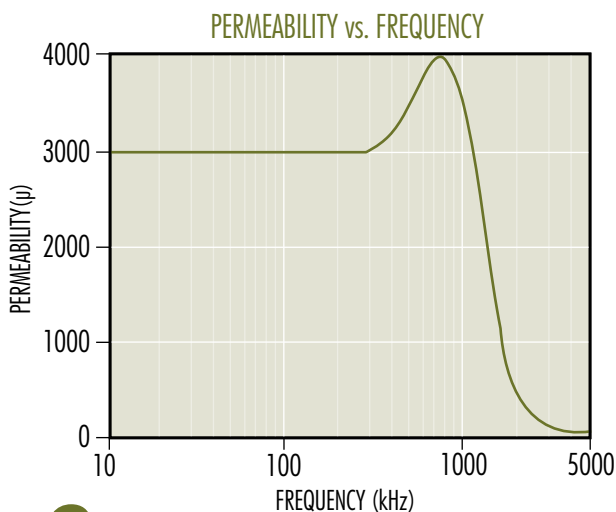
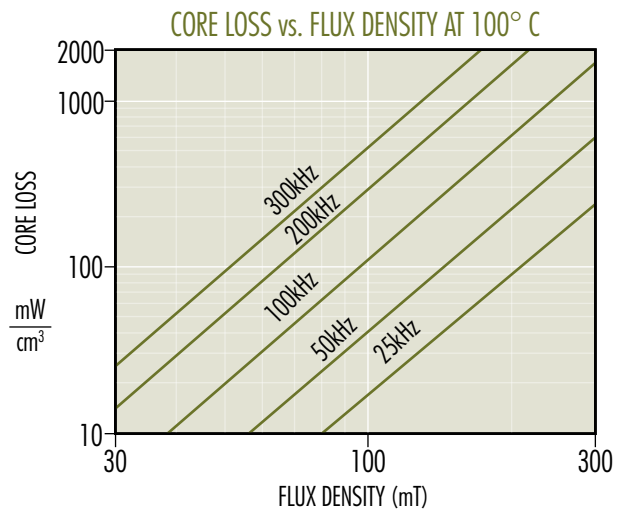
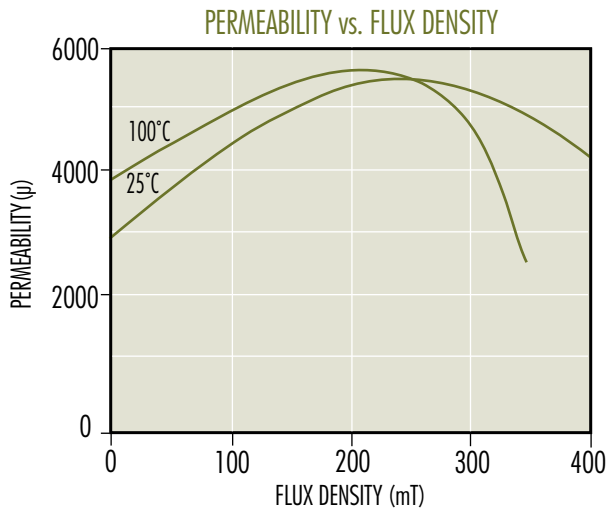
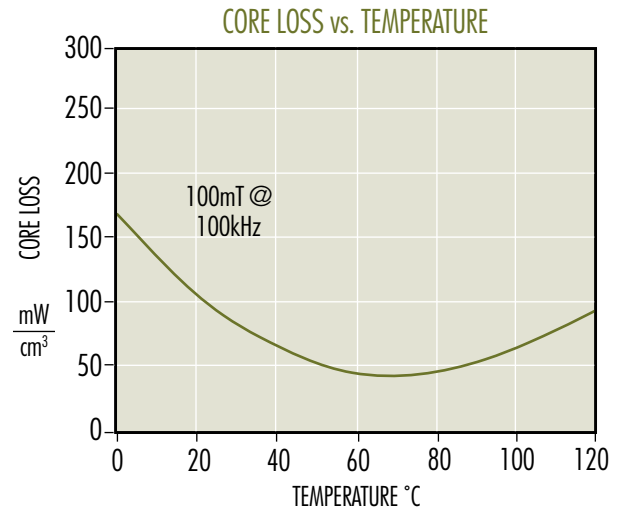
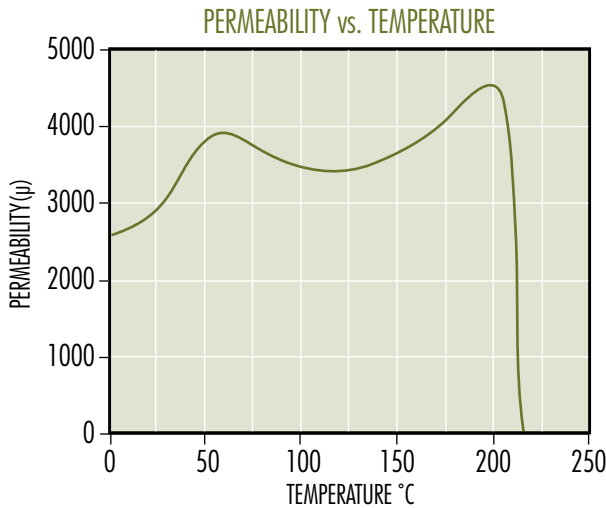

T Material

A power material for transformers and inductors operating from 20 kHz to 750 kHz. T material offers stability in both perm and losses over a wide temperature range.

Initial Perm (25°C; ≤ 10 kHz) **3,000 \pm 25%**
 Saturation Flux Density (5,300 G at 15 Oe, 25°C) 530 mT, 11.9 A-T/cm
 Curie Temperature 220°C

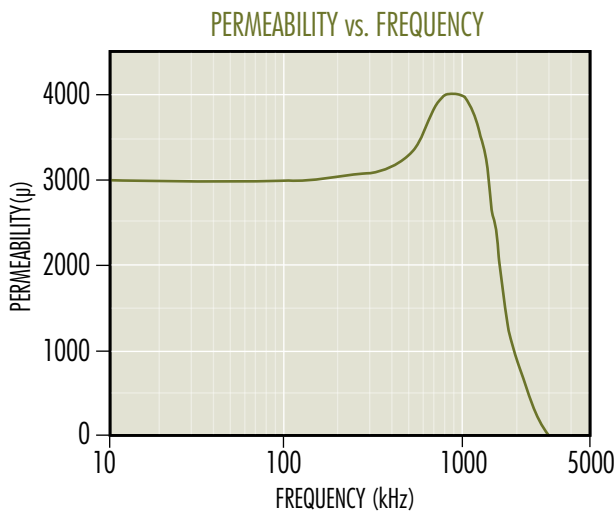
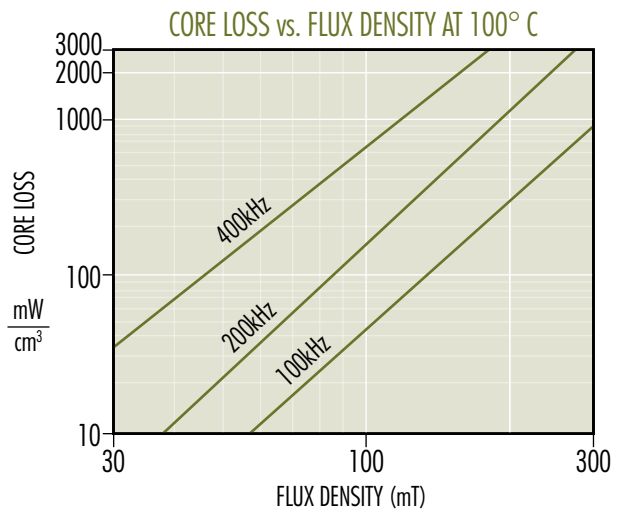
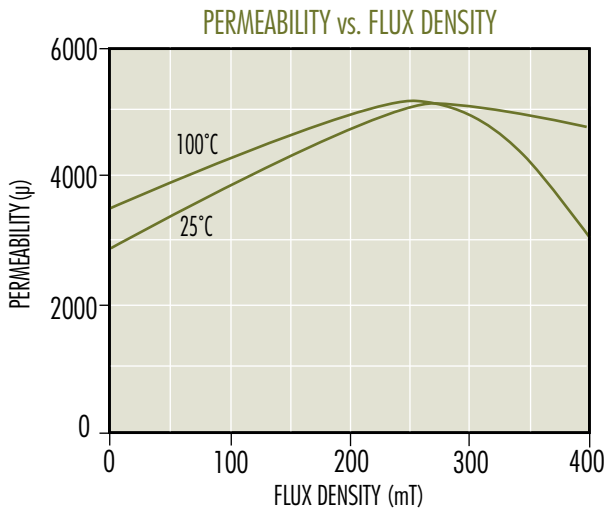
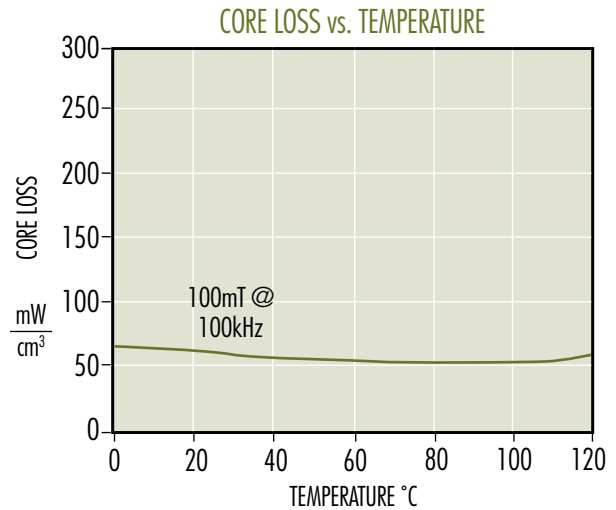
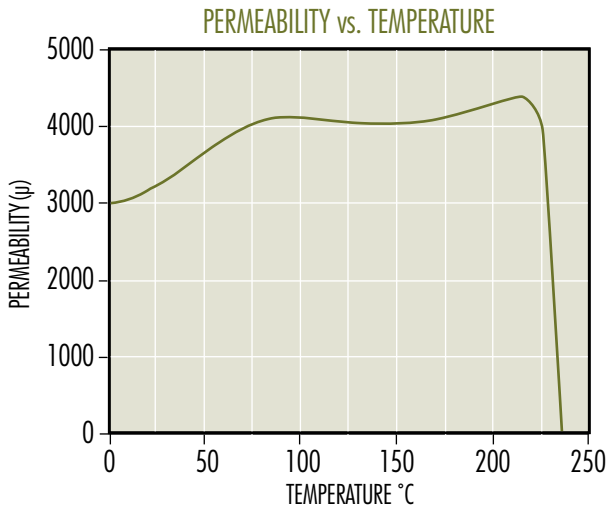

L Material

A high-frequency high-temperature power material.
L material is optimized for transformers and inductors from 500 kHz – 3 MHz. Core losses are minimized between 70 – 100°C.

Initial Perm (25°C; ≤ 10 kHz), Uncoated $900 \pm 25\%$
Initial Perm (25°C; ≤ 10 kHz), Coated $750 \pm 25\%$
Saturation Flux Density (4,200 G at 15 Oe, 25°C) 420 mT, 11.9 A-T/cm
Curie Temperature 300°C

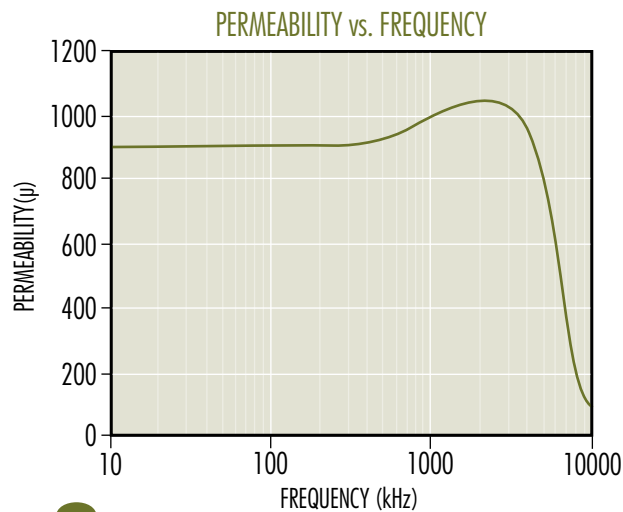
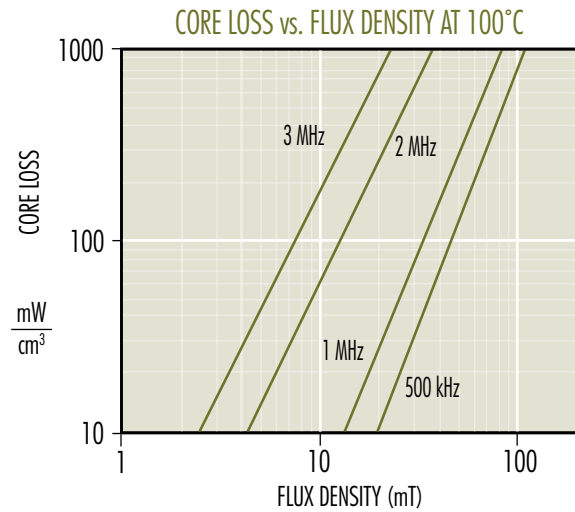
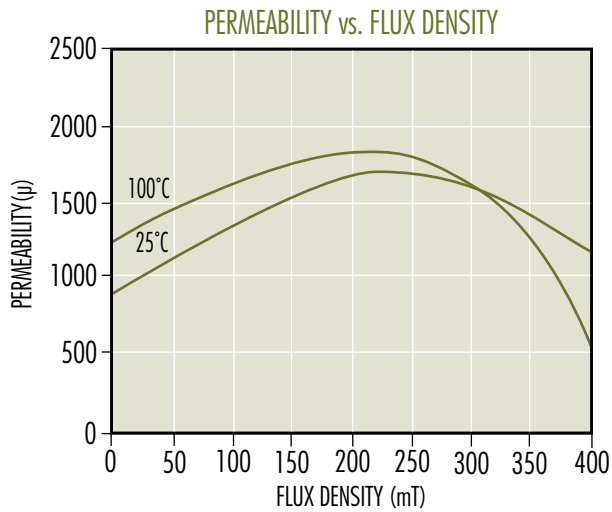
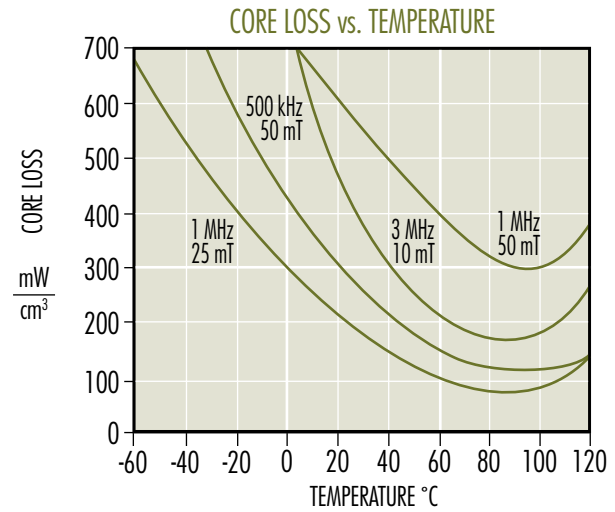
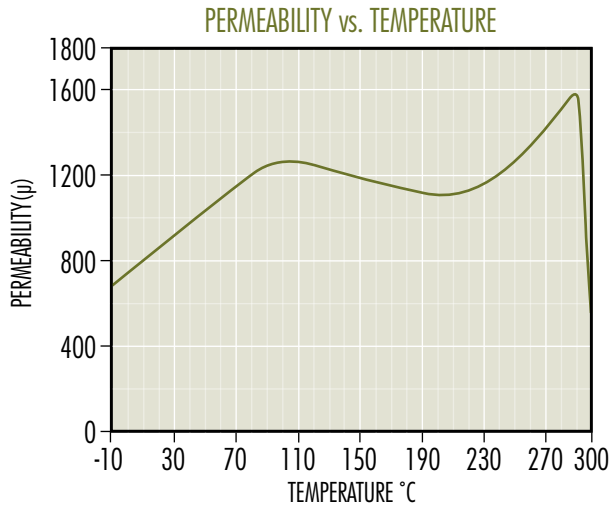

Materials

C, E and V materials work well for Telecom Filters, Wideband, Matching and Pulse transformer applications, and High Q inductors.

	C	E	V
Initial Perm	900 ± 25%	2,000 ± 25%	2,300 ± 25%
Saturation Flux Density	380 mT, 11.9 A·T/cm (3,800 G at 25°C, 15 Oe)	360 mT, 11.9 A·T/cm (3,600 G at 25°C, 15 Oe)	440 mT, 11.9 A·T/cm (4,400 G at 25°C, 15 Oe)
Curie Temperature	200°C	160°C	170°C

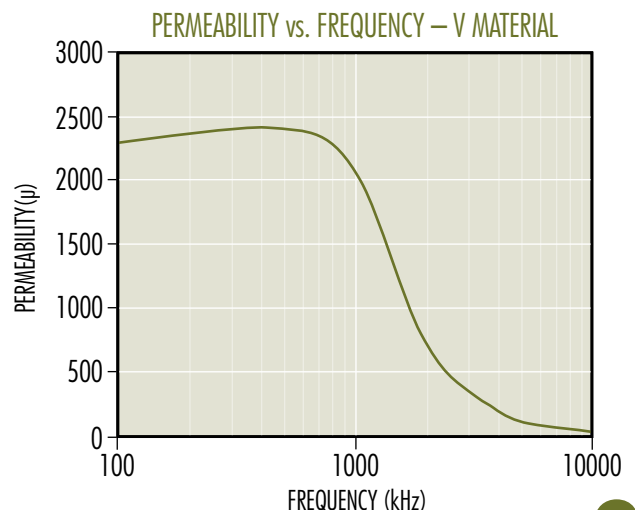
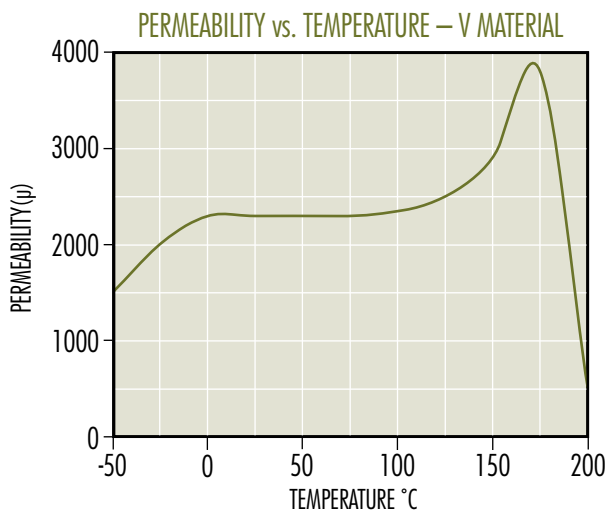
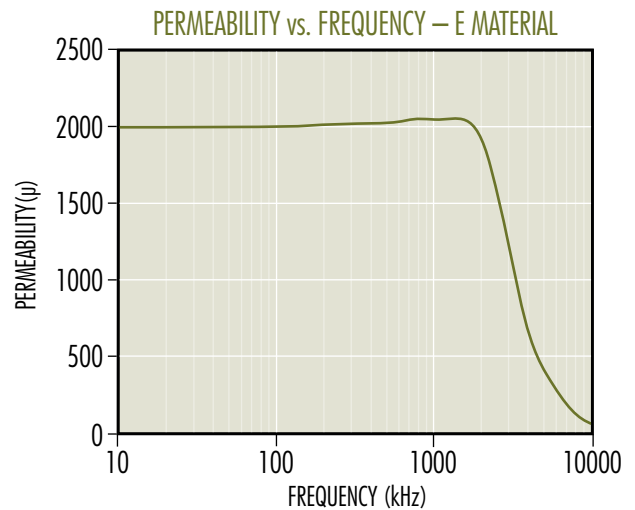
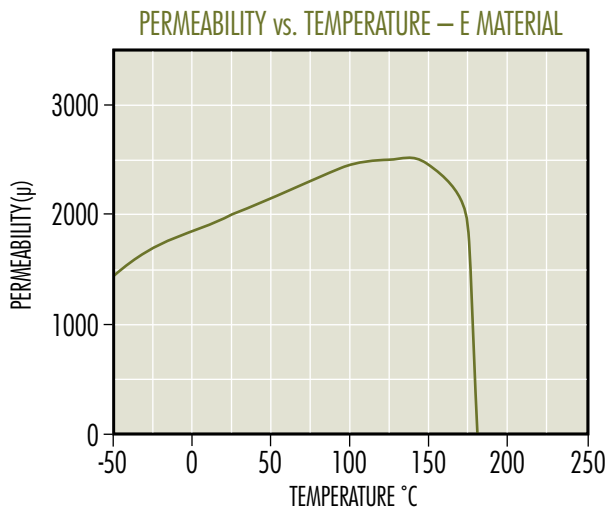
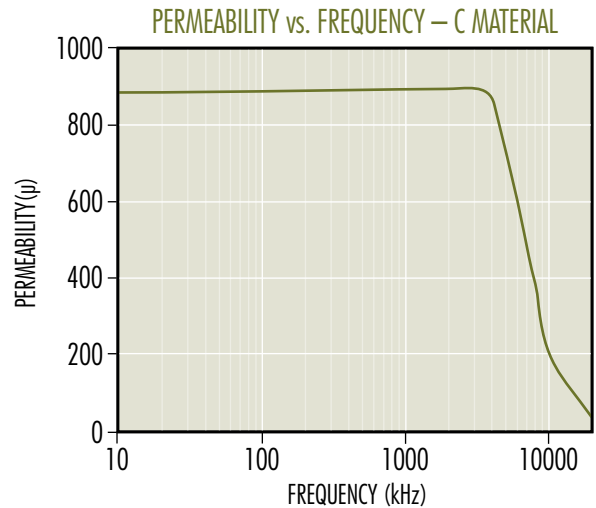
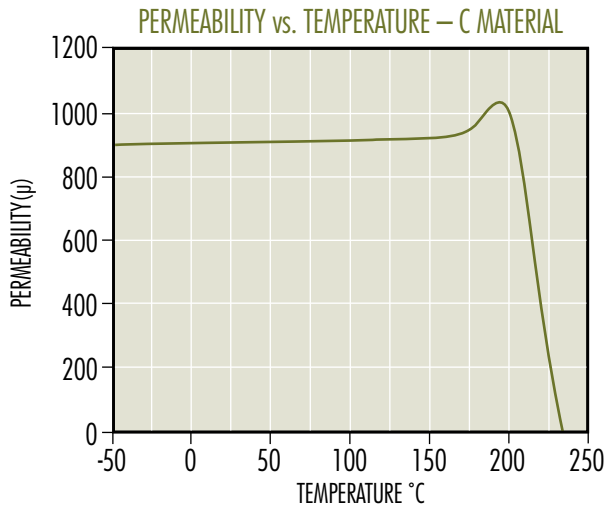

J Material

A medium perm general-purpose material. Well suited both for EMI/RFI filtering and broadband transformers.

Initial Perm (25°C; ≤ 10 kHz) $5,000 \pm 20\%$
Saturation Flux Density (4,300 G at 15 Oe, 25°C) 430 mT, 11.9 A-T/cm
Curie Temperature 145°C

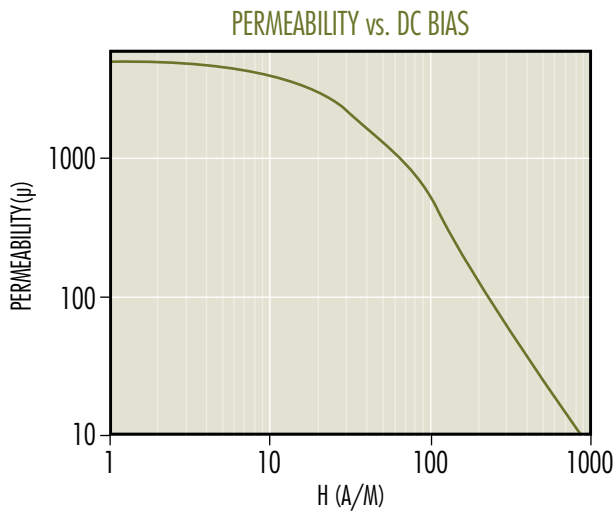
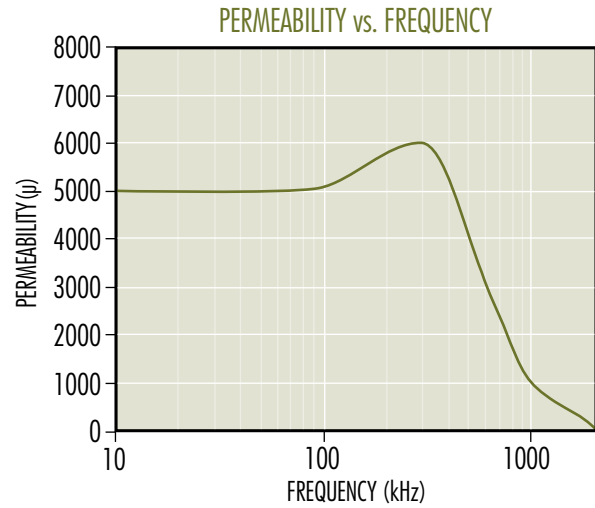
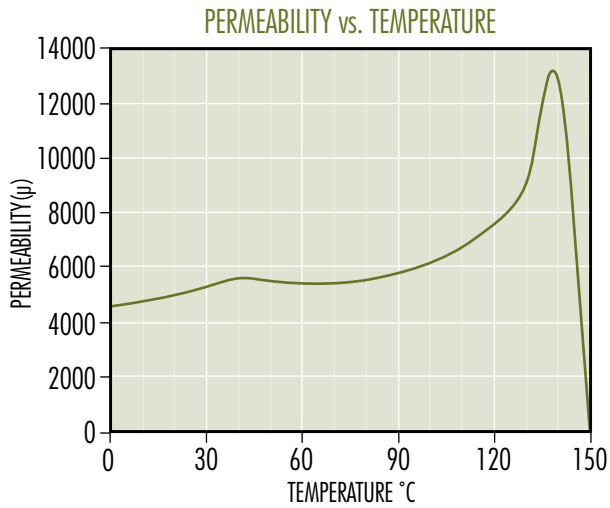

W Material

A high permeability material used for EMI/RFI suppression, common mode chokes, pulse and broadband transformers.

Available in shapes and toroids.

Initial Perm (25°C; ≤ 10 kHz) **10,000 \pm 30%**
Saturation Flux Density (3,900 G at 15 Oe, 25°C) 390 mT, 11.9 A-T/cm
Curie Temperature 135°C

PERMEABILITY vs. TEMPERATURE

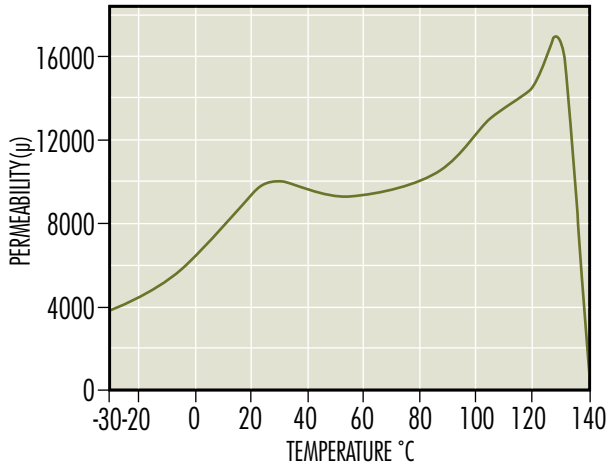

PERMEABILITY vs. FREQUENCY

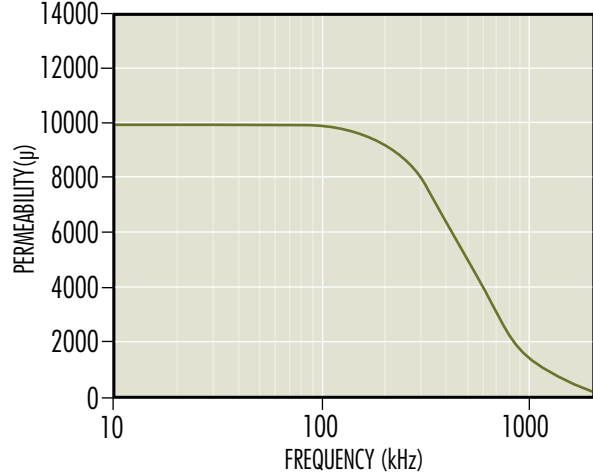

PERMEABILITY vs. DC BIAS

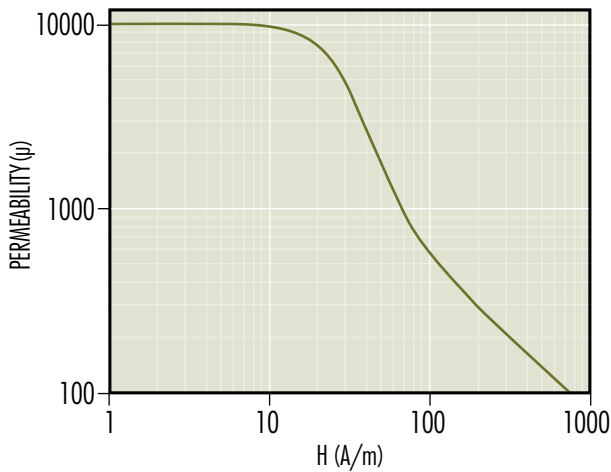

Gapped Cores

How To Order

Part Number

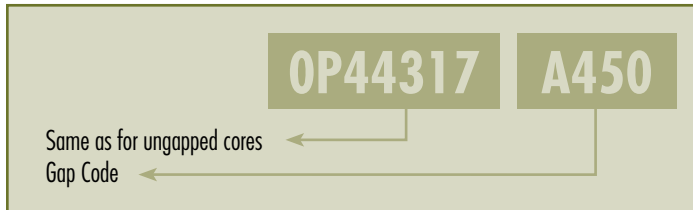

Gap Code

The letter indicates the type of gap and a three-digit number defines the value.

CODE	MEANING	EXAMPLE
A _ _ _	A_l (if <1000)	DF42311 A275 (A _l =275)
X _ _ _	A_l if 1000 or greater (add 1000 to code)	OP44721 X250 (A _l =1250)
F _ _ _	A_l if <100, non-integer (divide code by 10)	OR42510 F807 (A _l =80.7)
G _ _ _	Depth of Grind in mils (1000 ^{ths} of an inch)	OF44317 G079 (Gap=0.079")
M _ _ _	Depth of Grind , mm (divide code by 10)	OF43019 M015 (Gap=1.5 mm)

A_l is inductance factor, mH/1000 Turns, or nH/T².

Either the A_l or the depth of grind (not both) is controlled during production of gapped cores.

See the chart on pages 14-15 for tolerances.

Gap-to-Gap vs Ungapped-to-Gap Core Sets

"Gap-to-gap combination" means the gap is symmetrical. Half of the total gap is removed from each piece.

"Ungapped-to-gap combination" means an asymmetrical gap; the entire gap is taken from one piece, and the other piece is ungapped.

Gapping for A_l

In most applications, defining the gap with the A_l results in inductors with the least variation. Electrical measurement is inherently more precise, and compensation is made for variability in material permeability and core geometry.

When specifying and ordering E cores (including EC, EFD, EER, ETD, and Planar E cores) gapped to an A_l, it is important to note which cores are produced in gap-to-gap combination, because two gapped pieces are assembled to achieve the A_l. Alternatively, for E cores provided ungapped-to-gap, an ungapped piece must be used with a gapped piece to achieve the A_l. Pot, RS, DS, RM, PQ, and EP cores are sold as sets whether the combination is gap-to-gap or ungapped-to-gap.

A_l testing and limits are calculated to three significant digits, based on the normal value. For example, A_l=99±3% is interpreted as 96.0 Minimum, 99.0 Nominal, and 102.0 Maximum.

Magnetics tests gapped A_l values with full bobbins, usually 100 turns, or 250 turns for deep gaps. The drive level is low (5 Gauss) and the frequency is set low enough to avoid resonance effects. Measured inductance in an application may vary significantly from the theoretical value due to low turns, low bobbin fill, leakage effects, resonance effects, or elevated drive levels.

It is important for the users to verify the correlation between the test of the core and the specific test being applied to the inductor or transformer. Planar E cores, Planar RM, and Planar PQ cores are especially susceptible to correlation discrepancies.

Gapping for Depth of Grind

For parts ordered in pieces (E and I cores). The depth of grind is given for each piece.

For parts ordered in sets, the depth of grind is given as a total for the set, and may be ungapped-to-gap core pieces, or gap-to-gap. To make an ungapped-to-gap set, use one piece of each. For example, use OR41808G050 with OR41808EC for an asymmetrical gap of 0.050" ± 0.001". For the same gap, but symmetric, use two pieces of OR41808G025.

For deep gaps, however, better consistency often results when the depth of grind is specified. In such cases, variation in the finished inductor is dominated by the variation in the windings, especially if the number of turns is low.

Gapped Cores

Depth of Grind Tolerances

Tolerance Ranges for Pot, RS, DS, RM, PQ, and EP cores

INCHES		MILLIMETERS		GAP CONDITION
GAP	TOLERANCE	GAP	TOLERANCE	
0.001"–0.038"	±0.0005"	0.1 mm–0.9 mm	±0.03 mm	Ungapped to gap combination
0.039"–0.076"	±0.001"	1.0 mm–1.9 mm	±0.04 mm	Ungapped to gap combination (Except if the gap is more than 10% of the minimum bobbin depth for the set*, then gap-to-gap combination.)
0.077"–0.114"	±0.002"	2.0 mm–2.9 mm	±0.07 mm	Gap to gap combination (Except if the gap is less than 10% of the minimum bobbin depth for the set*, then ungapped-to-gap combination.)
0.115"–0.152"	±0.002"	3.0 mm–3.8 mm	±0.07 mm	Gap to gap combination
0.153"–0.228"	±0.004"	3.9 mm–5.0 mm	±0.12 mm	Gap to gap combination

*The bobbin depth for the set is the 2D dimension or 2 times the D dimension

Tolerance Ranges for E, EC, ER, EER, EFD, ETD and Planar E cores

INCHES		MILLIMETERS	
GAP	TOLERANCE	GAP	TOLERANCE
0.001"–0.038"	±0.0005"	0.1 mm–0.9 mm	±0.03 mm
0.039"–0.076"	±0.001"	1.0 mm–1.9 mm	±0.04 mm
0.077"–0.152"	±0.002"	2.0 mm–3.8 mm	±0.07 mm
0.153"–0.228"	±0.004"	3.9 mm–5.0 mm	±0.12 mm

Gapped Cores

A_L Value Tolerances

SIZE	GAP TO GAP ±3%	UNGAPPED TO GAP COMBINATION			
		±3%	±5%	±7%	±10%
E CORES		PAGE 24 - 27			
41203	16-27	28-55	≤86	≤117	≤160
41205	28-47	48-107	≤170	≤229	≤316
41707	22-37	38-89	≤140	≤190	≤259
41808	27-42	43-121	≤192	≤258	≤355
41810	44-74	75-235	≤376	≤512	≤704
42510	37-61	62-200	≤318	≤432	≤595
42515	28-43	44-210	≤333	≤452	≤616
42520	107-190	191-397	≤643	≤874	≤1202
42530	45-72	73-409	≤655	≤891	≤1225
43007	42-67	68-307	≤491	≤668	≤919
43009	55-91	92-222	≤353	≤475	≤653
43515	54-87	88-429	≤687	≤934	≤1284
43520	65-111	112-461	≤738	≤1003	≤1380
44011	59-95	96-642	≤1029	≤1400	≤1940
44016	52-83	84-545	≤872	≤1185	≤1629
44020	78-126	127-916	≤1480	≤1999	
44022	94-156	157-1187	≤1903	≤1999	
44317	81-136	137-762	≤1222	≤1676	≤1999
44721	107-180	181-1188	≤1920	≤1999	
45528	113-186	187-500	≤1999		
45530	150-360	361-600	≤1999		
45724	129-218	219-450	≤1999		
46016	102-129	130-1231	≤1999		
46527	142-235	236-650	≤1999		
47133	150-285	286-950	≤1999		
47228	120-199	200-1823	≤1999		
48020	99-158	159-1922	≤1999		
49928	150-285	286-975	≤1999		
EC CORES		PAGE 38 - 39			
43517	49-79	80-438	≤702	≤954	≤1312
44119	61-98	99-627	≤1004	≤1365	≤1891
45224	76-123	124-911	≤1471	≤1999	
47035	83-135	136-1403	≤1999		

*These tolerances also apply to Planar E-I combination.

SIZE	GAP TO GAP ±3%	UNGAPPED TO GAP COMBINATION			
		±3%	±5%	±7%	±10%
PLANAR E CORES*		PAGE 28 - 31			
41425	19-35	36-76	≤122	≤166	≤228
41434	17-31	32-77	≤123	≤167	≤230
41805	18-32	33-205	≤329	≤448	≤617
42107	35-66	67-188	≤304	≤414	≤569
42216	78-141	142-405	≤656	≤892	≤1239
43208	118-216	217-643	≤1040	≤1427	≤1964
43618	119-222	223-673	≤1088	≤1491	≤1999
43808	173-315	316-956	≤1547	≤1999	
44008	106-189	190-507	≤821	≤1116	≤1548
44308	201-367	368-1130	≤1828	≤1999	
44310	169-305	306-1130	≤1828	≤1999	
45810	266-481	482-1496	≤1999		
46410	379-701	702-1999			
49938	336-594	595-1999			
ER CORES		PAGE 32 - 33			
40906	15-65	66-70	≤110	≤150	≤200
41126	40-74	75-100	≤140	≤190	≤275
41426	45-84	85-130	≤190	≤250	≤380
41826	50-84	85-200	≤325	≤445	≤650
42313	55-90	91-200	≤525	≤710	≤900
43021	80-169	170-710	≤1050	≤1460	≤1975
EER/ETD CORES		PAGE 40 - 41/44 - 45			
43434	55-88	89-500	≤806	≤1095	≤1507
43521	54-86	87-566	≤913	≤1241	≤1707
43939	95-156	157-641	≤1028	≤1398	≤1935
44216	71-117	118-876	≤1415	≤1925	≤1999
44444	73-117	118-881	≤1423	≤1935	≤1999
44949	81-130	131-1075	≤1736	≤1999	
45959	51-118	119-1822	≤1999		
EFD CORES		PAGE 42 - 43			
41212	18-29	30-90	≤130	≤170	≤230
41515	19-30	31-81	≤127	≤172	≤236
42019	29-45	46-220	≤350	≤430	≤575
42523	41-66	67-296	≤475	≤646	≤888
43030	50-90	91-450	≤790	≤975	≤1125

Gapped Cores

A_L Value Tolerances

SIZE	GAP TO GAP ±3%	UNGAPPED TO GAP COMBINATION			
		±3%	±5%	±7%	±10%
EP CORES		PAGE 48 - 49			
40707	25-50	51-75	≤125		≤160
41010	25-55	56-75	≤125		≤160
41313	25-75	76-110	≤175	≤275	≤315
41717	25-100	101-175	≤275	≤400	≤630
42120	25-180	181-450	≤630	≤850	≤1250
POT CORES		PAGE 50 - 51			
40704	25-35	36-62	≤95	≤125	≤175
40905	25-48	49-87	≤135	≤180	≤240
41107	25-75	76-135	≤220	≤285	≤399
41408	71-113	114-210	≤307	≤417	≤574
41811	96-174	175-326	≤523	≤712	≤988
41814	65-135	136-340	≤510	≤700	≤980
42213	113-204	205-482	≤779	≤1060	≤1459
42616	139-249	250-695	≤1125	≤1543	≤1999
43019	170-304	305-1015	≤1642	≤1999	
43622	222-399	400-1494	≤1999		
44229	169-389	390-1965	≤1999		
RS (ROUND-SLAB) CORES		PAGE 52 - 53			
41408		25-177	≤283	≤385	≤530
41811	25-39	40-270	≤400	≤525	≤800
42311	25-39	40-347	≤708	≤963	≤1325
42318	25-39	40-452	≤731	≤994	≤1378
42616	25-39	40-622	≤998	≤1369	≤1884
43019	25-62	63-918	≤1485	≤1999	
43622	40-62	63-1286	≤1999		
44229	40-62	63-1732	≤1999		

SIZE	GAP TO GAP ±3%	UNGAPPED TO GAP COMBINATION			
		±3%	±5%	±7%	±10%
DS (DOUBLE SLAB) CORES		PAGE 52 - 53			
42311	109-195	196-386	≤625	≤850	≤1170
42318	78-135	136-441	≤706	≤961	≤1332
42616	117-205	206-580	≤930	≤1276	≤1756
43019	149-264	265-873	≤1412	≤1922	≤1999
43622	170-300	301-1111	≤1797	≤1999	
44229	179-315	316-1543	≤1999		
PQ CORES		PAGE 54 - 55			
42016	60-184	185-467	≤755	≤1027	≤1425
42020	50-139	140-467	≤754	≤1026	≤1422
42610	200-396	397-777	≤1258	≤1728	≤1999
42614	110-334	335-645	≤1044	≤1421	≤1972
42620	95-296	297-888	≤1436	≤1955	≤1999
42625	77-234	235-880	≤1423	≤1936	≤1999
43214	127-416	417-548	≤885	≤1207	≤1661
43220	128-409	410-486	≤1369	≤1878	≤1999
43230	84-241	242-808	≤1305	≤1775	≤1999
43535	89-255	256-980	≤1575	≤1999	
44040	83-230	231-1006	≤1625	≤1999	
45050	128-210	210-1999			
RM CORES		PAGE 56 - 57			
41110	25-50	51-55	≤75	≤170	≤250
41510	56-98	99-162	≤258	≤352	≤484
41812	69-120	121-238	≤381	≤519	≤714
41912	69-120	121-238	≤381	≤519	≤714
42316	84-150	151-395	≤633	≤862	≤1195
42819	126-200	201-625	≤1002	≤1374	≤1892
43723	145-250	251-977	≤1580	≤1999	

Chart shows type of combination and the guaranteed tolerance for corresponding A_L ranges. Ranges indicated are the tolerances for standard gapped. For ± 5%, ± 7%, and ± 10%, the maximum A_L for each is shown. Standard cores are manufactured to the smallest allowed tolerances.

Toroids

2.54 mm – 12.7 mm

Ferrite toroids offer high magnetic efficiency as there is no air gap, and the cross sectional area is uniform. Available in many sizes (O.D. from 2.54 mm to 140 mm) and materials (permeabilities ranging from 900 to 10,000), this section lists common sizes.

Typical applications for high permeability toroids (J and W materials) include common mode chokes, broadband transformers, pulse transformers and current transformers. L, R, P, F and T material toroids are excellent choices for high frequency transformers.

SIZE (mm)	ORDERING CODE	COATING			NOMINAL A _L (MH/1000T)						
		V	Y	Z	L ± 25%	R ± 25%	P ± 25%	F ± 20%	J ± 20%	W ± 30%	C ± 25%
2.54 x 1.27 x 1.27	0_40200TC		✓			400	454	525	875	1,750	158
3.46 x 1.78 x 1.27	0_40301TC		✓			380	410	495	825	1,650	149
3.94 x 2.24 x 1.27	0_40502TC		✓			340	368	440	735	1,470	129
3.94 x 2.24 x 2.54	0_40503TC		✓			670	716	885	1,475	2,950	258
4.83 x 2.29 x 1.27	0_40401TC		✓			440	474	570	950	1,900	170
4.83 x 2.29 x 2.54	0_40402TC		✓			870	948	1,140	1,900	3,800	341
5.84 x 3.05 x 1.52	0_40601TC		✓		178	450	488	585	980	1,960	177
5.84 x 3.05 x 3.18	0_40603TC		✓		372	940	1,020	1,225	2,040	4,080	372
7.62 x 3.18 x 4.78	0_40705TC		✓		751	1,920	2,088	2,505	4,175	8,350	751
9.53 x 5.59 x 7.11	0_40907TC		✓	✓	683	1,730	1,884	2,260	3,765	7,530	683
9.53 x 4.75 x 3.18	0_41003TC		✓	✓	399	1,000	1,095	1,314	2,196	4,392	399
9.53 x 4.75 x 4.78	0_41005TC		✓	✓	599	1,510	1,650	1,980	3,308	6,616	599
12.7 x 5.16 x 6.35	0_41206TC	✓	✓	✓	1,029	2,600	2,820	3,384	5,640	11,280	1,029
12.7 x 8.14 x 3.18	0_41303TC	✓	✓	✓	255	680	745	894	1,488	2,976	254
12.7 x 8.14 x 3.89	0_41304TC	✓	✓	✓	311	850	931	1,116	1,860	3,720	311
12.7 x 8.14 x 5.08	0_41305TC	✓	✓	✓	407	1,090	1,190	1,430	2,380	4,760	406
12.7 x 8.14 x 6.35	0_41306TC	✓	✓	✓	508	1,360	1,485	1,782	2,968	5,936	508

Nominal A_L values for L perm are based on uncoated toroids. For specific values of any core, see the datasheet.

HOW TO ORDER

O J 4 14 06 TC

- Coating code ←
- Ferrite core material ←
- Used for all ferrite types ←
- Approximate diameter in mm ←
- Approximate height in mm ←
- Geometry code ←

COATING CODE

- O – Bare core
- V – Nylon coating
- Y – Parylene coating
- Z – Epoxy coating

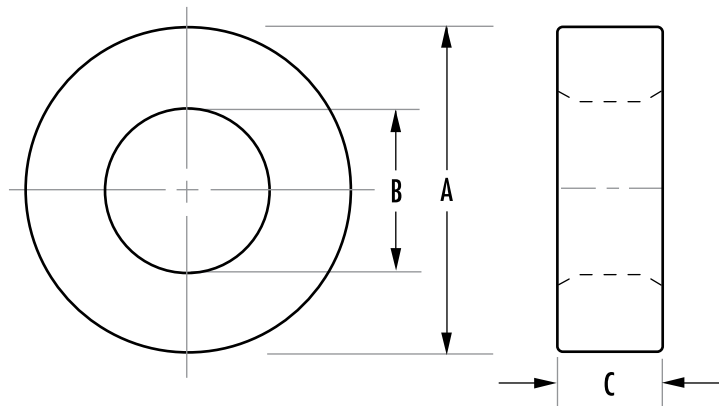



SIZE (mm)	ORDERING CODE	MAGNETIC DATA						HARDWARE	
		I_e (mm)	A_e (mm ²)	V_e (mm ³)	Window Area (cm ²)	WaAc (cm ⁴)	Weight (grams per piece)	Headers & Mounts	Cups
2.54 x 1.27 x 1.27	O_40200TC	5.5	0.77	4.3	0.01	0.0001	0.03		
3.46 x 1.78 x 1.27	O_40301TC	7.65	1.03	7.87	0.02	0.0003	0.04		
3.94 x 2.24 x 1.27	O_40502TC	9.2	1.05	9.7	0.03	0.0004	0.05		
3.94 x 2.24 x 2.54	O_40503TC	9.2	2.1	19.4	0.03	0.0008	0.10		
4.83 x 2.29 x 1.27	O_40401TC	10.2	1.5	15.7	0.04	0.0006	0.09		
4.83 x 2.29 x 2.54	O_40402TC	10.2	3.1	31.5	0.04	0.001	0.17		
5.84 x 3.05 x 1.52	O_40601TC	13.0	2.0	26.7	0.07	0.001	0.14		
5.84 x 3.05 x 3.18	O_40603TC	13.0	4.3	56.0	0.07	0.003	0.30		
7.62 x 3.18 x 4.78	O_40705TC	15.0	9.9	149	0.07	0.008	0.90		
9.53 x 5.59 x 7.11	O_40907TC	22.7	13.7	310	0.24	0.03	1.60		
9.53 x 4.75 x 3.18	O_41003TC	20.7	7.3	151	0.17	0.01	0.82		
9.53 x 4.75 x 4.78	O_41005TC	20.7	10.9	227	0.17	0.02	1.20		
12.7 x 5.16 x 6.35	O_41206TC	25.0	22.0	550	0.20	0.05	3.30		
12.7 x 8.14 x 3.18	O_41303TC	31.7	7.1	226	0.49	0.04	1.20		
12.7 x 8.14 x 3.89	O_41304TC	31.7	8.7	276	0.49	0.05	1.44		
12.7 x 8.14 x 5.08	O_41305TC	31.7	11.4	361	0.49	0.06	1.90		
12.7 x 8.14 x 6.35	O_41306TC	31.7	14.2	451	0.49	0.07	2.40		

Refer to page 58 for hardware information.

SIZE (mm)	ORDERING CODE	BARE NOMINAL DIMENSIONS (mm)			BARE LIMITING DIMENSIONS (mm)		
		OD (A)	ID (B)	HT (C)	OD (A) max	ID (B) min	HT (C) max
2.54 x 1.27 x 1.27	O_40200TC	2.54	1.27	1.27	2.75	1.06	1.45
3.46 x 1.78 x 1.27	O_40301TC	3.46	1.78	1.27	3.71	1.62	1.45
3.94 x 2.24 x 1.27	O_40502TC	3.94	2.24	1.27	4.14	2.03	1.45
3.94 x 2.24 x 2.54	O_40503TC	3.94	2.24	2.54	4.14	2.03	2.80
4.83 x 2.29 x 1.27	O_40401TC	4.83	2.29	1.27	5.03	2.08	1.45
4.83 x 2.29 x 2.54	O_40402TC	4.83	2.29	2.54	5.03	2.08	2.80
5.84 x 3.05 x 1.52	O_40601TC	5.84	3.05	1.52	6.13	2.76	1.71
5.84 x 3.05 x 3.18	O_40603TC	5.84	3.05	3.18	6.13	2.76	3.43
7.62 x 3.18 x 4.78	O_40705TC	7.62	3.18	4.78	7.88	2.92	4.91
9.53 x 5.59 x 7.11	O_40907TC	9.53	5.59	7.11	9.78	5.33	7.29
9.53 x 4.75 x 3.18	O_41003TC	9.53	4.75	3.18	9.78	4.49	3.31
9.53 x 4.75 x 4.78	O_41005TC	9.53	4.75	4.78	9.78	4.49	4.91
12.7 x 5.16 x 6.35	O_41206TC	12.7	5.16	6.35	12.96	4.90	6.53
12.7 x 8.14 x 3.18	O_41303TC	12.7	8.14	3.18	12.96	7.67	3.31
12.7 x 8.14 x 3.89	O_41304TC	12.7	8.14	3.89	12.96	7.67	4.09
12.7 x 8.14 x 5.08	O_41305TC	12.7	8.14	5.08	12.96	7.67	5.26
12.7 x 8.14 x 6.35	O_41306TC	12.7	8.14	6.35	12.96	7.67	6.53

Toroids

12.7 mm – 25.34 mm



SIZE (mm)	ORDERING CODE	COATING			NOMINAL A_L (MH/1000T)							
		V	Y	Z	L \pm 25%	R \pm 25%	P \pm 25%	F \pm 20%	T \pm 25%	J \pm 20%	W \pm 30%	C \pm 25%
12.7 x 7.14 x 5.08	O_41405TC	✓	✓	✓	526	1,320	1,440	1,730		2,890	5,780	500
12.7 x 7.14 x 6.35	O_41406TC	✓	✓	✓	658	1,660	1,805	2,166		3,612	7,224	625
12.7 x 7.14 x 4.78	O_41407TC	✓	✓	✓	495	1,240	1,356	1,630		2,715	5,430	470
12.7 x 7.14 x 7.62	O_41410TC	✓		✓	790	1,990	2,162	2,595		4,335	8,675	790
13.2 x 7.37 x 3.96	O_41506TC	✓		✓	415	1,020	1,111	1,334		2,295	4,590	315
13.6 x 7.01 x 3.51	O_41435TC	✓		✓	419	1,040	1,130	1,350		2,260	4,520	418
14.0 x 8.99 x 5.0	O_41450TC	✓		✓	399	990	1,080	1,290		2,160	4,320	397
15.9 x 9.07 x 4.7	O_41605TC	✓		✓	475	1,260	1,375	1,650	1,650	2,760	5,520	475
15.9 x 9.07 x 9.4	O_41610TC	✓		✓	950	2,450	2,660	3,200		5,410	10,600	950
18.4 x 9.75 x 10.3	O_41809TC	✓		✓	1,177	2,810	3,050	3,660		6,115	12,200	1,177
20.6 x 12.7 x 6.35	O_42106TC	✓		✓	553	1,380	1,500	1,680		2,800	5,600	553
20.6 x 12.7 x 8.89	O_42109TC	✓		✓	774	1,930	2,100	2,520		4,200	8,400	774
22.1 x 13.7 x 6.35	O_42206TC	✓		✓	547	1,380	1,510	1,812	1,821	3,020	6,040	538
22.1 x 13.7 x 7.9	O_42207TC	✓		✓	680	1,720	1,875	2,250		3,700	7,400	671
22.1 x 13.7 x 12.7	O_42212TC	✓		✓	1,093	2,770	3,020	3,624		6,040	12,080	1,084
25.34 x 15.45 x 7.66	O_42507TC	✓		✓	705	1,800	1,958	2,348		3,913	7,825	690
25.34 x 15.45 x 10.0	O_42508TC	✓		✓	891	2,220	2,420	2,900		4,830	9,660	

Nominal A_L values for L perm are based on uncoated toroids. For specific values of any core, see the datasheet.

HOW TO ORDER

O J 4 14 06 TC

- Coating code ← O
- Ferrite core material ← J
- Used for all ferrite types ← 4
- Approximate diameter in mm ← 14
- Approximate height in mm ← 06
- Geometry code ← TC

COATING CODE

- O – Bare core
- V – Nylon coating
- Y – Parylene coating
- Z – Epoxy coating

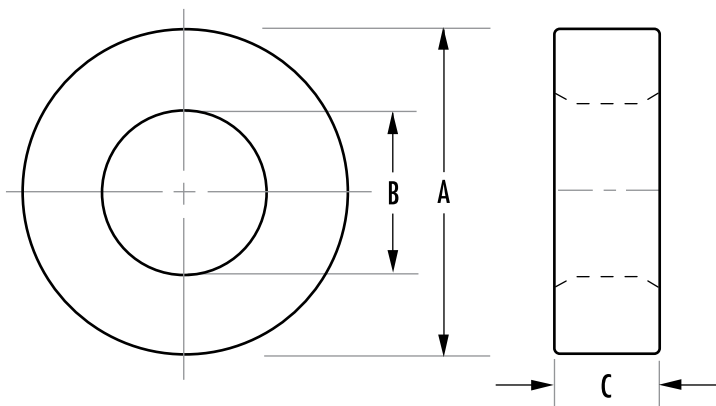



SIZE (mm)	ORDERING CODE	MAGNETIC DATA						HARDWARE	
		I_e (mm)	A_e (mm ²)	V_e (mm ³)	Window Area (cm ²)	WaAc (cm ⁴)	Weight (grams per piece)	Headers & Mounts	Cups
12.7 x 7.14 x 5.08	O_41405TC	29.5	13.7	405	0.40	0.05	2.03		
12.7 x 7.14 x 6.35	O_41406TC	29.5	17.1	507	0.40	0.07	2.70	✓	
12.7 x 7.14 x 4.78	O_41407TC	29.5	12.9	381	0.40	0.05	1.90	✓	
12.7 x 7.14 x 7.62	O_41410TC	29.5	20.6	608	0.40	0.17	3.04		
13.2 x 7.37 x 3.96	O_41506TC	30.6	11.2	343	0.42	0.05	1.9	✓	
13.6 x 7.01 x 3.51	O_41435TC	30.1	11.1	335	0.36	0.04	1.7		
14.0 x 8.99 x 5.0	O_41450TC	35.0	12.3	430	0.63	0.08	2.2	✓	
15.9 x 9.07 x 4.7	O_41605TC	37.2	15.6	580	0.62	0.10	2.8	✓	
15.9 x 9.07 x 9.4	O_41610TC	37.2	31.2	1,164	0.62	0.20	5.8		
18.4 x 9.75 x 10.3	O_41809TC	41.4	43.1	1,783	0.74	0.32	9.9	✓	
20.6 x 12.7 x 6.35	O_42106TC	50.3	24.6	1,238	1.27	0.31	5.4	✓	
20.6 x 12.7 x 8.89	O_42109TC	50.3	34.4	1,733	1.27	0.43	8.1	✓	
22.1 x 13.7 x 6.35	O_42206TC	54.1	26.2	1,417	1.48	0.39	6.4	✓	
22.1 x 13.7 x 7.9	O_42207TC	54.2	32.5	1,763	1.48	0.48	8.5	✓	
22.1 x 13.7 x 12.7	O_42212TC	51.9	52.3	2,834	1.48	0.77	13.5	✓	
25.34 x 15.45 x 7.66	O_42507TC	61.5	37.1	2,284	1.89	0.69	11.6	✓	
25.34 x 15.45 x 10.0	O_42508TC	61.5	48.0	2,981	1.89	0.89	14.9	✓	

Refer to page 58 for hardware information.

SIZE (mm)	ORDERING CODE	BARE NOMINAL DIMENSIONS (mm)			BARE LIMITING DIMENSIONS (mm)		
		OD (A)	ID (B)	HT (C)	OD (A) max	ID (B) min	HT (C) max
12.7 x 7.14 x 5.08	O_41405TC	12.7	7.14	5.08	12.96	6.88	5.26
12.7 x 7.14 x 6.35	O_41406TC	12.7	7.14	6.35	12.96	6.88	6.53
12.7 x 7.14 x 4.78	O_41407TC	12.7	7.14	4.78	12.96	6.88	4.91
12.7 x 7.14 x 7.62	O_41410TC	12.7	7.14	7.62	12.96	6.88	7.88
13.2 x 7.37 x 3.96	O_41506TC	13.2	7.37	3.96	13.47	7.11	4.09
13.6 x 7.01 x 3.51	O_41435TC	13.6	7.01	3.51	13.85	6.75	3.64
14.0 x 8.99 x 5.0	O_41450TC	14.0	8.99	5.0	14.25	8.73	5.14
15.9 x 9.07 x 4.7	O_41605TC	15.9	9.07	4.7	16.26	8.5	4.83
15.9 x 9.07 x 9.4	O_41610TC	15.9	9.07	9.4	16.26	8.5	9.66
18.4 x 9.75 x 10.3	O_41809TC	18.4	9.75	10.3	18.83	9.37	10.52
20.6 x 12.7 x 6.35	O_42106TC	20.6	12.7	6.35	20.96	12.31	6.53
20.6 x 12.7 x 8.89	O_42109TC	20.6	12.7	8.89	20.96	12.31	9.15
22.1 x 13.7 x 6.35	O_42206TC	22.1	13.7	6.35	22.48	13.33	6.53
22.1 x 13.7 x 7.9	O_42207TC	22.1	13.7	7.9	22.48	13.33	8.18
22.1 x 13.7 x 12.7	O_42212TC	22.1	13.7	12.7	22.48	13.33	12.96
25.34 x 15.45 x 7.66	O_42507TC	25.34	15.45	7.66	25.91	14.98	8.18
25.34 x 15.45 x 10.0	O_42508TC	25.34	15.45	10.0	25.91	14.98	10.27

Toroids

26.9 mm – 46.9 mm



SIZE (mm)	ORDERING CODE	COATING			NOMINAL A_L (MH/1000T)					
		V	Y	Z	R ± 25%	P ± 25%	F ± 20%	T ± 25%	J ± 20%	W ± 30%
26.9 x 14.2 x 12.2	0_42712TC	✓		✓	3,610	3,920	4,710		7,650	15,300
29 x 19 x 7.43	0_42908TC	✓		✓	1,450	1,585	1,902		3,170	6,340
29 x 19 x 15.2	0_42915TC			✓	2,960	3,222	3,868		6,447	12,894
30.8 x 19.1 x 12.7	0_43113TC			✓	2,850	3,100	3,720		6,200	12,400
32 x 15 x 4.5	0_43205TC			✓	1,480	1,610	1,930		3,220	6,440
36 x 23 x 10	0_43610TC			✓	2,030	2,210	2,726		4,543	9,085
36 x 23 x 15	0_43615TC			✓	3,100	3,366	4,040		6,736	13,400
36 x 23 x 20	0_43620TC			✓					9,086	
38.1 x 19 x 6.35	0_43806TC			✓	2,020	2,200	2,640		4,400	8,800
38.1 x 19 x 12.7	0_43813TC			✓	3,850	4,185	5,020		8,365	16,700
38.1 x 19 x 25.4	0_43825TC			✓	8,060	8,762	10,040		16,730	33,400
41.8 x 26.2 x 18	0_44015TC			✓	3,860	4,200	5,040	5,040	8,408	16,816
44.3 x 19 x 15.9	0_44416TC			✓	5,360	5,830	7,000		11,600	23,200
44.3 x 19 x 19.1	0_44419TC			✓		7,970	9,550			
46.9 x 27 x 15	0_44715TC			✓	3,700	4,030	4,840		8,075	16,100

Nominal A_L values for L perm are based on uncoated toroids. For specific values of any core, see the datasheet.

HOW TO ORDER

O J 4 14 06 TC

Coating code ←
 Ferrite core material ←
 Used for all ferrite types ←
 Approximate diameter in mm ←
 Approximate height in mm ←
 Geometry code ←

COATING CODE

O – Bare core
 V – Nylon coating
 Y – Parylene coating
 Z – Epoxy coating

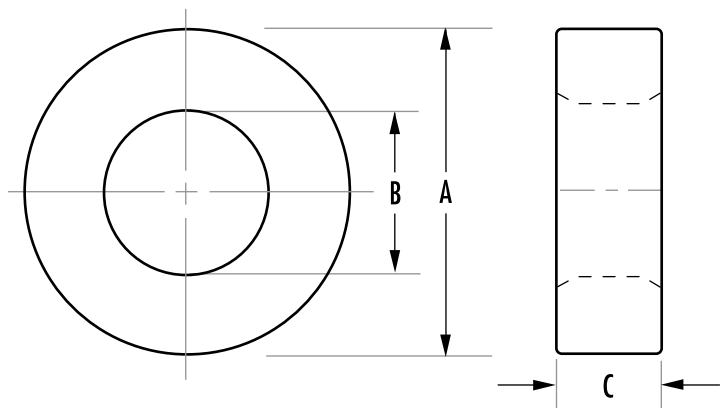



SIZE (mm)	ORDERING CODE	MAGNETIC DATA						HARDWARE	
		I _e (mm)	A _e (mm ²)	V _e (mm ³)	Window Area (cm ²)	WaAc (cm ⁴)	Weight (grams per piece)	Headers & Mounts	Cups
26.9 x 14.2 x 12.2	0_42712TC	60.2	73.2	4,410	1.57	1.16	22.5		
29 x 19 x 7.43	0_42908TC	73.2	37.0	2,679	2.84	1.05	12.9	✓	
29 x 19 x 15.2	0_42915TC	73.2	74.9	5,481	2.84	2.13	27.6	✓	
30.8 x 19.1 x 12.7	0_43113TC	75.4	73.6	5,547	2.83	2.11	29.3	✓	
32 x 15 x 4.5	0_43205TC	67.2	36.4	2,451	0.34	0.61	12.9	✓	
36 x 23 x 10	0_43610TC	89.7	63.9	5,731	4.15	2.65	29.4	✓	
36 x 23 x 15	0_43615TC	89.6	95.9	8,596	2.85	3.98	44	✓	
36 x 23 x 20	0_43620TC	89.6	128	11,461	4.15	5.31	54		
38.1 x 19 x 6.35	0_43806TC	82.9	58.3	4,826	2.85	1.66	26.4	✓	
38.1 x 19 x 12.7	0_43813TC	82.9	115.6	9,652	2.85	3.28	51.7	✓	
38.1 x 19 x 25.4	0_43825TC	82.8	233	19,304	2.85	6.56	103.4	✓	
41.8 x 26.2 x 18	0_44015TC	103	138	14,205	5.39	7.44	68.9	✓	
44.3 x 19 x 15.9	0_44416TC	88.0	187	16,559	2.85	5.33	80.8	✓	
44.3 x 19 x 19.1	0_44419TC	88.0	228	20,146	2.85	6.50	107.9	✓	
46.9 x 27 x 15	0_44715TC	110.4	145.5	16,063	5.72	8.34	84.0	✓	

Refer to page 58 for hardware information.

SIZE (mm)	ORDERING CODE	BARE NOMINAL DIMENSIONS (mm)			BARE LIMITING DIMENSIONS (mm)		
		OD (A)	ID (B)	HT (C)	OD (A) max	ID (B) min	HT (C) max
26.9 x 14.2 x 12.2	0_42712TC	26.9	14.2	12.2	27.63	13.39	12.62
29 x 19 x 7.43	0_42908TC	29.0	19.0	7.43	29.52	18.49	7.68
29 x 19 x 15.2	0_42915TC	29.0	19.0	15.2	29.52	18.49	15.63
30.8 x 19.1 x 12.7	0_43113TC	30.8	19.1	12.7	31.5	18.49	13.26
32 x 15 x 4.5	0_43205TC	32.0	15.0	4.5	33.28	14.4	4.68
36 x 23 x 10	0_43610TC	36.0	23.0	10.0	36.7	22.5	10.27
36 x 23 x 15	0_43615TC	36.0	23.0	15.0	36.7	22.5	15.24
36 x 23 x 20	0_43620TC	36.0	23.0	20.0	36.7	22.5	20.56
38.1 x 19 x 6.35	0_43806TC	38.1	19.0	6.35	38.87	18.28	6.53
38.1 x 19 x 12.7	0_43813TC	38.1	19.0	12.7	38.87	18.28	12.96
38.1 x 19 x 25.4	0_43825TC	38.1	19.0	25.4	38.87	18.28	25.91
41.8 x 26.2 x 18	0_44015TC	41.8	26.2	18.0	42.8	25.6	18.4
44.3 x 19 x 15.9	0_44416TC	44.3	19.0	15.7	45.22	18.28	16.26
44.3 x 19 x 19.1	0_44419TC	44.3	19.0	19.1	45.22	18.28	19.66
46.9 x 27 x 15	0_44715TC	46.9	27.0	15.0	47.65	26.23	15.27

Toroids

49.1 mm – 140 mm



SIZE (mm)	ORDERING CODE	COATING			NOMINAL A _L (MH/1000T)				
		V	Y	Z	R ± 25%	P ± 25%	F ± 20%	J ± 20%	W ± 30%
49.1 x 33.8 x 15.9	0_44916TC			✓	2,710	2,950	3,540	5,900	11,800
49.1 x 31.8 x 15.9	0_44920TC			✓	2,790	3,032	3,640	6,065	12,130
49.1 x 31.8 x 19.05	0_44925TC			✓	3,420	3,718	4,460	7,435	14,870
49.1 x 33.8 x 31.3	0_44932TC			✓	5,430	5,900	7,080	11,800	23,600
60.96 x 41.78 x 12.7	0_46013TC			✓				4,800	9,483
60.96 x 41.78 x 19.05	0_46019TC			✓				7,100	
61 x 35.6 x 12.7	0_46113TC			✓	3,140	3,491	4,107	6,845	13,690
63 x 38 x 24.5	0_46325TC			✓					21,056
63 x 38 x 24.5	0_46326TC			✓	5,770	6,270	7,530	12,500	
73.7 x 38.9 x 12.5	0_47313TC			✓	3,700	4,024	4,880	8,140	16,280
73.7 x 38.9 x 25.2	0_47325TC			✓	7,400	8,050	9,760	16,280	
85.7 x 55.5 x 12.7	0_48613TC			✓	2,510	2,726	3,310	5,520	11,040
85.7 x 55.5 x 25.4	0_48625TC			✓	5,040	5,480	6,570	10,960	
85.7 x 55.5 x 25.4	0_48626TC			✓					18,760
102 x 65.8 x 15	0_49715TC			✓	3,025	3,464	3,945	6,575	11,178
107 x 65 x 18	0_49718TC			✓	4,127	4,486	5,383	8,972	15,252
107 x 65 x 25	0_49725TC			✓	5,732	6,230	7,477	12,461	21,184
140 x 106 x 25	0_49740TC			✓	3,200	3,477	4,173	6,955	11,823

HOW TO ORDER

O J 4 14 06 TC

- Coating code ←
- Ferrite core material ←
- Used for all ferrite types ←
- Approximate diameter in mm ←
- Approximate height in mm ←
- Geometry code ←

COATING CODE

- O – Bare core
- V – Nylon coating
- Y – Parylene coating
- Z – Epoxy coating

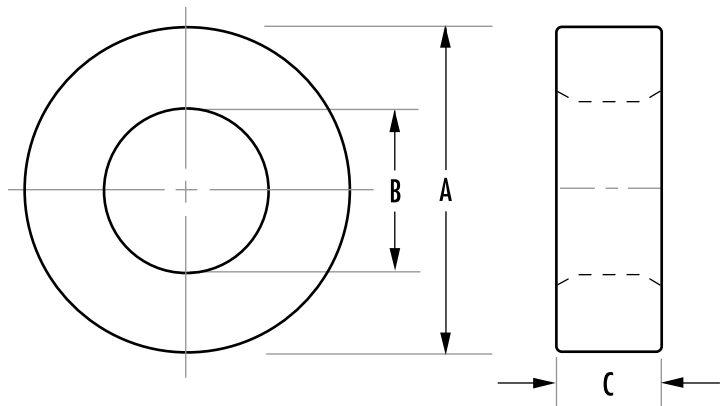



SIZE (mm)	ORDERING CODE	MAGNETIC DATA						HARDWARE	
		I _e (mm)	A _e (mm ²)	V _e (mm ³)	Window Area (cm ²)	WaAc (cm ⁴)	Weight (grams per piece)	Headers & Mounts	Cups
49.1 x 33.8 x 15.9	0_44916TC	127	120	15,298	8.99	10.6	75.3	✓	
49.1 x 31.8 x 15.9	0_44920TC	123.2	135.4	16,676	7.94	9.45	83	✓	
49.1 x 31.8 x 19.05	0_44925TC	123	162	20,000	7.94	12.8	98	✓	
49.1 x 33.8 x 31.3	0_44932TC	127	237	30,100	8.99	21.2	150.6	✓	
60.96 x 41.78 x 12.7	0_46013TC	157.6	120.4	18,968	13.68	16.48	94		
60.96 x 41.78 x 19.05	0_46019TC	157.6	180.5	28,453	13.68	24.7	141		
61 x 35.6 x 12.7	0_46113TC	144.6	157.4	22,774	9.93	15.5	113	✓	
63 x 38 x 24.5	0_46325TC	152	300	45,598	11.1	33.2	225		
63 x 38 x 24.5	0_46326TC	152	300	45,600	11.3	33.9	225	✓	
73.7 x 38.9 x 12.5	0_47313TC	165	210	34,771	11.9	25	172		
73.7 x 38.9 x 25.2	0_47325TC	165	423	70,099	11.9	50.3	347		
85.7 x 55.5 x 12.7	0_48613TC	214.9	188.8	40,582	24.2	45.7	201		
85.7 x 55.5 x 25.4	0_48625TC	215	375	80,700	24.2	90.8	399		
85.7 x 55.5 x 25.4	0_48626TC	215	377	81,165	24.2	91.2	402		
102 x 65.8 x 15	0_49715TC	255.3	267.2	68,821	34	90.8	341		
107 x 65 x 18	0_49718TC	259.31	370.27	96,013	28.6	106	475		
107 x 65 x 25	0_49725TC	259.31	514.3	133,351	33.2	171	660		
140 x 106 x 25	0_49740TC	381.5	422.3	161,086	88.2	372	797		

Refer to page 58 for hardware information.

SIZE (mm)	ORDERING CODE	BARE NOMINAL DIMENSIONS (mm)			BARE LIMITING DIMENSIONS (mm)		
		OD (A)	ID (B)	HT (C)	OD (A) max	ID (B) min	HT (C) max
49.1 x 33.8 x 15.9	0_44916TC	49.1	33.8	15.9	49.84	33.07	16.26
49.1 x 31.8 x 15.9	0_44920TC	49.1	31.8	15.9	49.84	31.03	16.26
49.1 x 31.8 x 19.05	0_44925TC	49.1	31.8	19.05	49.84	31.03	19.44
49.1 x 33.8 x 31.3	0_44932TC	49.1	33.8	31.3	49.84	33.07	32.26
60.96 x 41.78 x 12.7	0_46013TC	60.96	41.78	12.7	61.86	40.88	12.96
60.96 x 41.78 x 19.05	0_46019TC	60.96	41.78	19.05	61.86	40.88	19.43
61 x 35.6 x 12.7	0_46113TC	61	35.6	12.7	61.85	34.67	12.96
63 x 38 x 24.5	0_46325TC	63	38	24.5	64.34	36.65	25.58
63 x 38 x 24.5	0_46326TC	63	38	24.5	63.89	37.1	25.38
73.7 x 38.9 x 12.5	0_47313TC	73.7	38.9	12.5	74.68	37.9	12.96
73.7 x 38.9 x 25.2	0_47325TC	73.7	38.9	25.2	74.7	37.9	25.91
85.7 x 55.5 x 12.7	0_48613TC	85.7	55.5	12.7	87	54.28	12.96
85.7 x 55.5 x 25.4	0_48625TC	85.7	55.5	25.4	87	54.28	25.91
85.7 x 55.5 x 25.4	0_48626TC	85.7	55.5	25.4	87.63	53.64	26.54
102 x 65.8 x 15	0_49715TC	102	65.8	15	104	64.5	15.5
107 x 65 x 18	0_49718TC	107	65	18	109	63.7	18.35
107 x 65 x 25	0_49725TC	107	65	25	109	63.7	25.75
140 x 106 x 25	0_49740TC	140	106	25	143	104	26

E, I Cores

9 mm – 35 mm

E cores are less expensive than pot cores, and have the advantage of simple bobbin winding plus easy assembly. E cores do not, however, offer self-shielding. Lamination size E cores are available to fit commercially offered bobbins previously designed to fit the strip stampings of standard lamination sizes. Metric and DIN sizes are also available. E cores can be pressed to different thicknesses, providing a selection of cross-sectional areas. E cores can be mounted in different directions and, if desired, provide a low profile.

Typical applications for E cores include differential mode, power and telecom inductors, as well as, broadband, power, converter and inverter transformers.

TYPE/SIZE	ORDERING CODE	NOMINAL A _L (MH/1000T)						
		L	R	P	F	T	J	W
E 9/4/2	O_40904EC	280	493	540	650		1,040	
E 13/7/3	O_41203EC	350	587	640	770		1,367	
E 13/7/6	O_41205EC	700	1,467	1,600	1,950		3,300	
E 17/7/4	O_41707EC	520	1,013	1,100	1,300		1,900	
E 19/8/5	O_41808EC	550	1,153	1,253	1,500	1,500	2,500	4,293
E 19/8/10	O_41810EC	1,000	2,300	2,500	3,000		5,000	8,600
E 25/10/7	O_42510EC	800	1,767	1,920	2,300		3,700	7,660
E 25/13/7	O_42513EC	900	1,900	2,314	2,460		4,000	
E 25/16/6	O_42515EC	540	1,153	1,253	1,500		2,400	
I 25/3/6	O_42515IC	820	1,760	1,913	2,290		3,667	
E 25/10/13	O_42520EC	1,600	3,533	3,840	4,600		7,400	13,813
E 25/13/11	O_42526EC		2,800	3,512	4,068	4,068	5,951	
E 25/16/13	O_42530EC	1,070	2,307	2,507	3,000		4,800	8,213
E 31/15/7	O_43007EC	920	2,060	2,240	2,700		3,800	8,200
E 31/13/9	O_43009EC	1,400	2,893	3,147	3,780		5,893	
E 34/14/9	O_43515EC		2,667	2,907	3,500		5,813	11,414
E 35/21/9	O_43520EC		1,947	2,120	2,555		4,240	

HOW TO ORDER

O R 4 30 07 EC

Shape code ←

Ferrite core material ←

Used for all ferrite types ←

Approximate length in mm ←

Approximate height in mm ←

Geometry code ←

GEOMETRY CODE

EC – E core

IC – I core

Cores are sold per piece (for sets multiply by 2).

Any practical gap available. See page 14.

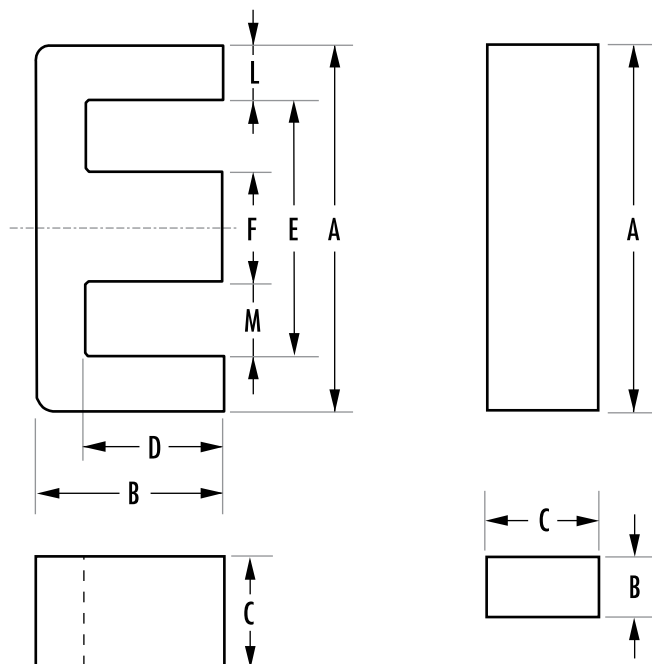

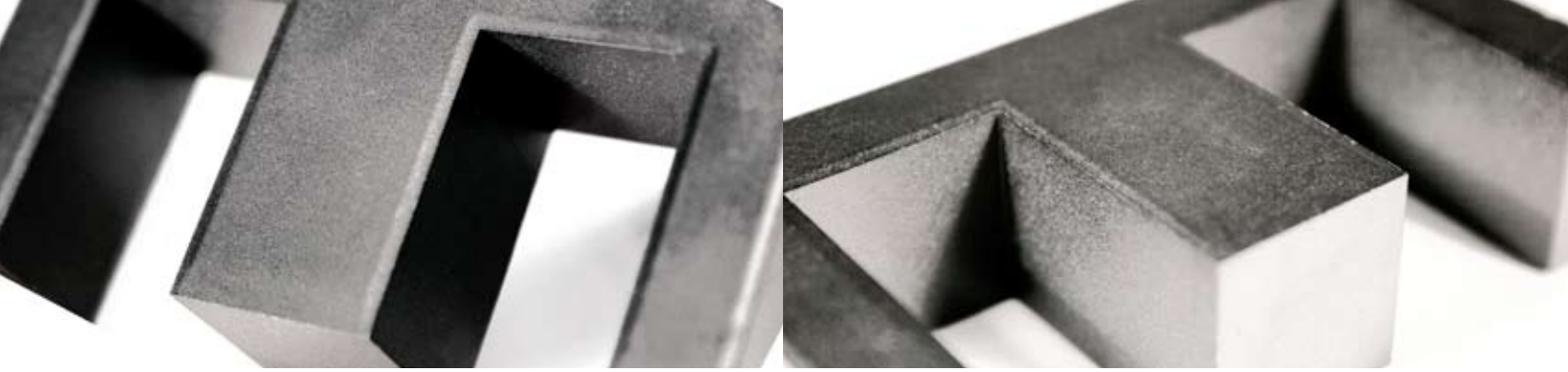

		MAGNETIC DATA						HARDWARE	
TYPE/SIZE	ORDERING CODE	l_e (mm)	A_e (mm ²)	A_{min} (mm ²)	V_e (mm ³)	$WaAc$ (cm ⁴)	Weight (grams per set)	Bobbins	Clips
E 9/4/2	O_40904EC	15.6	5.0	3.6	78	0.002	0.7		
E 13/7/3	O_41203EC	27.8	10.1	10.1	279	0.016	1.3		
E 13/7/6	O_41205EC	27.7	20.2	20.0	558	0.03	2.6		
E 17/7/4	O_41707EC	30.4	16.6	12.6	505	0.03	3.0		
E 19/8/5	O_41808EC	39.9	22.6	22.1	900	0.08	4.4	✓	
E 19/8/10	O_41810EC	40.1	45.5	45.4	1,820	0.14	8.5		
E 25/10/7	O_42510EC	49.0	39.5	37.0	1,930	0.16	9.5	✓	
E 25/13/7	O_42513EC	57.8	51.8	51.8	2,990	0.27	16		
E 25/16/6	O_42515EC	73.5	40.1	39.7	2,950	0.56	15	✓	
I 25/3/6	O_42515IC	48.3	39.8	38.7	1,920	0.18	10		
E 25/10/13	O_42520EC	48.0	78.4	76.8	3,760	0.48	19	✓	
E 25/13/11	O_42526EC	57.5	78.4	76.8	4,500	0.41	36		
E 25/16/13	O_42530EC	73.5	80.2	79.4	5,900	0.74	30		
E 31/15/7	O_43007EC	67.0	60.0	49.0	4,000	0.50	20	✓	
E 31/13/9	O_43009EC	61.9	83.2	83.2	5,150	0.59	26	✓	
E 34/14/9	O_43515EC	69.3	80.7	80.7	5,590	0.98	28	✓	
E 35/21/9	O_43520EC	94.3	90.6	90.5	8,540	1.68	42		

Refer to page 58 for hardware information.

		DIMENSIONS (mm)							
TYPE/SIZE	ORDERING CODE	A	B	C	D	E	F	L	M
E 9/4/2	O_40904EC	9.0 ± 0.4	4.06 ± 0.25	1.91 ± 0.13	2.03 min	4.85 min	1.91 ± 0.13	1.91 ± 0.25	1.57 ± 0.25
E 13/7/3	O_41203EC	12.7 ± 0.25	5.69 ± 0.18	3.18 ± 0.13	3.96 min	9.19 min	3.18 ± 0.08	1.57 nom	3.05 min
E 13/7/6	O_41205EC	12.7 ± 0.25	5.69 ± 0.18	6.4 ± 0.15	3.96 min	9.2 min	3.2 ± 0.13	1.57 ref	3.05 min
E 17/7/4	O_41707EC	16.8 ± .38	7.11 ± 0.18	3.56 ± 0.12	3.94 min	10.4 min	3.56 ± 0.13	2.79 nom	3.63 min
E 19/8/5	O_41808EC	19.1 ± .4	8.1 ± 0.13	4.75 ± 0.2	5.7 ± 0.13	14.33 ± 0.33	4.75 ± 0.2	2.38 nom	4.79 nom
E 19/8/10	O_41810EC	19.1 ± .4	8.1 ± 0.18	9.53 ± 0.13	5.7 min	14.0 min	4.75 ± 0.2	2.38 ref	4.79 ref
E 25/10/7	O_42510EC	25.4 ± .6	9.65 ± 0.2	6.35 ± 0.25	6.4 min	18.8 min	6.35 ± 0.25	3.3 nom	6.1 min
E 25/13/7	O_42513EC	25.0 + 0.8/-0.7	12.8 + 0/-0.4	7.5 + 0/-0.6	8.7 + 0.6/0	17.5 + 0.9/0	7.5 + 0/-0.5	3.55 ref	5.35 ref
E 25/16/6	O_42515EC	25.4 ± 0.38	15.9 ± 0.25	6.35 ± 0.25	12.6 min	18.8 min	6.35 ± 0.13	3.12 ± 0.13	6.4 ± 0.25
I 25/3/6	O_42515IC	25.4 ± 0.38	3.18 ± 0.12	6.35 ± 0.25					
E 25/10/13	O_42520EC	25.4 ± 0.6	9.65 ± 0.2	12.7 ± 0.25	6.4 min	18.8 min	6.35 ± 0.25	3.6 max	6.1 min
E 25/13/11	O_42526EC	25.0 + 0.8/-0.7	12.8 + 0/-0.5	11 + 0/-0.5	8.7 + 0.5/0	17.5 + 1/0	7.5 + 0/-0.5	3.53 ref	5.37 ref
E 25/16/13	O_42530EC	25.4 ± 0.38	15.9 ± 0.25	12.7 ± 0.25	12.6 min	18.8 min	6.35 ± 0.13	3.12 ± 0.13	6.4 ± 0.25
E 31/15/7	O_43007EC	30.8 + 0/-1.4	15.0 ± 0.2	7.3 ± 0/-0.5	9.71 + 0.5/0	19.5 + 1/0	7.2 + 0/-0.5	5.65 nom	6.15 nom
E 31/13/9	O_43009EC	30.95 ± 0.5	13.1 ± 0.25	9.4 ± 0.3	8.5 min	21.4 min	9.4 ± 0.13	4.29 nom	6.0 min
E 34/14/9	O_43515EC	34.3 ± 0.6	14.1 ± 0.15	9.3 ± 0.25	9.8 ± 0.13	25.5 min	9.3 ± 0.2	4.7 max	8.0 min
E 35/21/9	O_43520EC	34.9 ± 0.38	20.6 ± 0.25	9.53 ± 0.18	15.6 min	25.1 min	9.53 ± 0.25	4.75 ± 0.25	7.95 nom

E, I Cores

40 mm – 100 mm



TYPE/SIZE	ORDERING CODE	NOMINAL A _L (MH/1000T)					
		R	P	F	T	J	W
E 40/17/11	O_44011EC	4,000	4,347	5,200		7,293	
E 42/21/9	O_44016EC	2,667	2,907	3,495		5,647	
E 43/21/15	O_44020EC	4,600	5,000	6,000	5,300	9,700	
I 43/6/15	O_44020IC	6,253	6,800				
E 43/21/20	O_44022EC	5,533	6,013	7,600	6,950	10,613	
E 42/33/20	O_44033EC	4,000	4,709	5,562		8,727	
E 41/17/12	O_44317EC	3,900	4,240	5,900		9,800	18,293
E 47/20/16	O_44721EC	5,360	5,827	8,300			
E 56/28/21	O_45528EC	6,293	6,840	8,220	8,625		
E 56/28/25	O_45530EC	7,520	8,173	9,800	9,860	14,920	
E 56/24/19	O_45724EC	8,093	8,800	10,400	10,440	14,580	24,000
E 60/22/16	O_46016EC	5,733	6,240	6,590			
E 65/32/27	O_46527EC	8,600	9,200		10,600		
E 70/33/32	O_47133EC	10,800	11,600	13,400			
E 72/28/19	O_47228EC	5,960	6,480	7,780		11,850	
E 80/38/20	O_48020EC	4,673	5,080	6,000			
E 100/59/27	O_49928EC	6,227	6,773				

HOW TO ORDER

OR 47228 EC

- Shape code ←
- Ferrite core material ←
- Used for all ferrite types ←
- Approximate length in mm ←
- Approximate height in mm ←
- Geometry code ←

GEOMETRY CODE

EC – E core
 IC – I core
 Cores are sold per piece (for sets multiply by 2).
 Any practical gap available. See page 14.

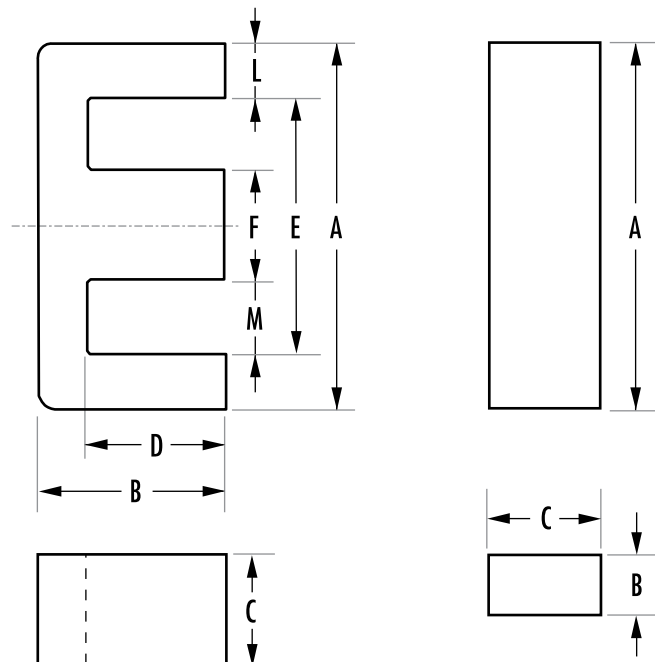

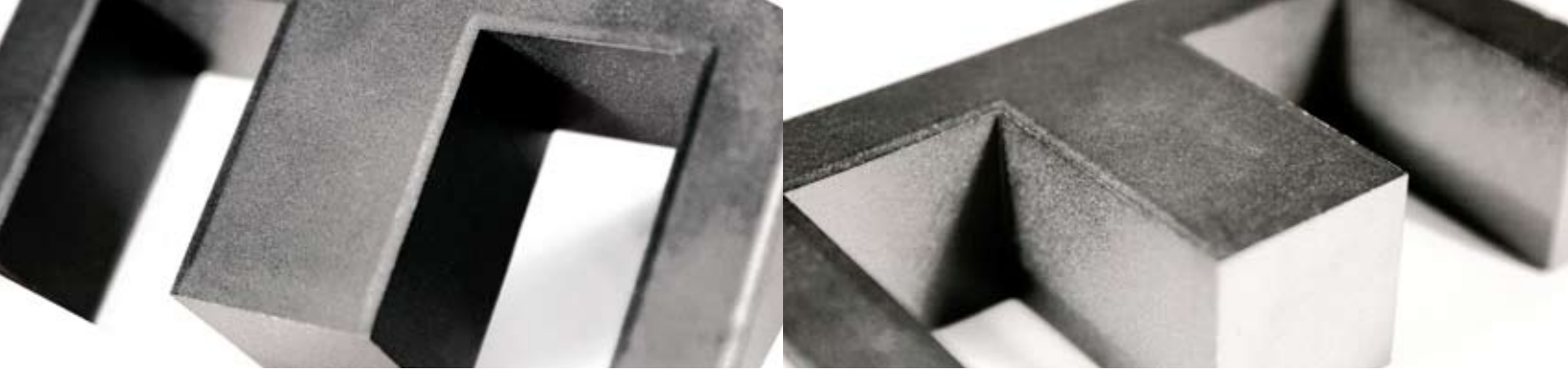

		MAGNETIC DATA						HARDWARE	
TYPE/SIZE	ORDERING CODE	l_e (mm)	A_e (mm ²)	A min (mm ²)	V_e (mm ³)	WaAc (cm ⁴)	Weight (grams per set)	Bobbins	Clips
E 40/17/11	O_44011EC	76.7	127	114	9,780	1.26	49		
E 42/21/9	O_44016EC	98.4	107	106	10,500	1.65	52		
E 43/21/15	O_44020EC	97.0	178	175	17,300	3.55	87	✓	
I 43/6/15	O_44020IC	67.1	177	176	11,900	1.36	60		
E 43/21/20	O_44022EC	97.0	233	233	22,700	4.22	114	✓	
E 42/33/20	O_44033EC	145	236	234	34,200	6.36	164		
E 41/17/12	O_44317EC	77.0	149	142	11,500	1.88	57	✓	
E 47/20/16	O_44721EC	88.9	234	226	20,800	3.3	103	✓	
E 56/28/21	O_45528EC	124	353	345	44,000	9.78	212	✓	
E 56/28/25	O_45530EC	123	420	411	52,000	12.1	255	✓	
E 56/24/19	O_45724EC	107	337	337	36,000	6.98	179	✓	
E 60/22/16	O_46016EC	110	248	240	27,200	5.74	135		
E 65/32/27	O_46527EC	147	540	530	79,000	23.5	410	✓	
E 70/33/32	O_47133EC	149	683	676	102,000	23.3	495		
E 72/28/19	O_47228EC	137	368	363	50,300	15.0	250	✓	
E 80/38/20	O_48020EC	184	392	392	72,300	31.6	357	✓	
E 100/59/27	O_49928EC	274	738	692	202,000	90.6	980		

Refer to page 58 for hardware information.

		DIMENSIONS (mm)							
TYPE/SIZE	ORDERING CODE	A	B	C	D	E	F	L	M
E 40/17/11	O_44011EC	40.0 ± 0.51	17.0 ± 0.31	10.69 ± 0.31	10.0 min	27.6 min	10.7 ± 0.31	5.99 ± 0.25	8.86 nom
E 42/21/9	O_44016EC	42.15 ± 0.85	21.1 ± 0.2	9.0 ± 0.25	14.9 min	29.5 min	11.95 ± 0.25	5.94 ± 0.13	8.9 ± 0.25
E 43/21/15	O_44020EC	43.0 + 0/-1.7	21.0 ± 0.2	15.2 + 0/-0.6	14.8 + 0.6/-0	29.5 + 1.4/-0	12.2 + 0/-0.5	6.75 nom	8.65 nom
I 43/6/15	O_44020IC	43.0 + 0/-1.7	5.9 ± 0.2	15.2 + 0/-0.6					
E 43/21/20	O_44022EC	43.0 + 0/-1.7	21.0 ± 0.2	20.0 + 0/-0.8	14.8 + 0.6/-0	29.5 + 1.4/-0	12.2 + 0/-0.5	6.75 nom	8.65 nom
E 42/33/20	O_44033EC	42.0 + 1/-0.7	32.8 + 0/-0.4	20.0 + 1/-0.8	26.0 + 1/-0	29.5 + 1.4/-0	12.2 + 0/-0.5	5.98 ref	9.13 ref
E 41/17/12	O_44317EC	40.6 ± 0.65	16.6 ± 0.2	12.4 ± 0.3	10.4 min	28.6 min	12.45 ± 0.25	6.33 max	7.95 min
E 47/20/16	O_44721EC	46.9 ± 0.8	19.6 ± 0.2	15.6 ± 0.25	12.1 min	32.4 ± 0.65	15.6 ± 0.25	7.54 nom	7.87 min
E 56/28/21	O_45528EC	56.2 + 0/-2.1	27.5 ± 0.3	21.0 + 0/-0.8	18.5 + 0.8/-0	37.5 + 1.5/-0	17.2 + 0/-0.5	9.35 ref	10.15 ref
E 56/28/25	O_45530EC	56.2 + 0/-2.1	27.6 ± 0.38	24.61 ± 0.38	18.5 min	37.5 min	17.2 + 0/-0.5	9.35 ref	10.15 ref
E 56/24/19	O_45724EC	56.1 ± 1	23.6 ± 0.25	18.8 ± 0.25	14.6 ± 0.13	38.1 min	18.8 ± 0.25	9.5 nom	9.03 nom
E 60/22/16	O_46016EC	59.99 ± 0.78	22.3 ± 0.3	15.62 ± 0.38	13.8 min	44.0 min	15.62 ± 0.38	7.7 ± 0.25	14.49 ± 0.25
E 65/32/27	O_46527EC	65.0 + 1.5/-1.2	32.8 + 0/-0.6	27.4 + 0/-0.8	22.0 + 0.8/-0	44.2 + 1.8/-0	20.0 + 0/-0.7	9.95 ref	12.72 ref
E 70/33/32	O_47133EC	70.5 ± 1	33.2 + 0/-0.5	32.0 + 0/-0.8	21.9 + 0.7/-0	48.0 + 1.5/-0	22.0 + 0/-0.7	11.25 nom	13.0 nom
E 72/28/19	O_47228EC	72.4 ± 0.76	27.9 ± 0.33	19.0 ± 0.33	17.8 min	52.6 min	19.0 ± 0.38	9.53 ± 0.38	16.9 min
E 80/38/20	O_48020EC	80.0 ± 1.6	38.1 ± 0.3	19.8 ± 0.4	28.2 ± 0.3	59.1 min	19.8 ± 0.4	11.25 nom	19.45 min
E 100/59/27	O_49928EC	100.3 ± 2.0	59.4 ± 0.47	27.5 ± 0.5	46.85 ± 0.38	72.0 min	27.5 ± 0.5	13.75 ± 0.38	22.65 ± 0.5

Planar E, I Cores

14 mm – 36 mm

Planar E cores are offered in all of the IEC standard sizes, and a number of other sizes. The leg length and window height (B and D dimensions) are adjustable for specific applications without new tooling. This permits the designer to adjust the final core specification to exactly accommodate the planar conductor stack height, with no wasted space. Clips and clip slots are available in many cases, which is useful for prototyping. I cores are also offered standard, reducing path length and increasing inductance. Planar cores provide the lowest profile design. E-I planar combinations allow practical face bonding in high volume assembly. The flat back can accommodate a heat sink.

Differential mode inductors, DC/DC, and AC/DC converters are typical applications for planar cores.

TYPE/SIZE	ORDERING CODE	NOMINAL A _L (MH/1000T)			
		L	R	P	F
14/2.5/5	O_41425EC	780	1,519	1,595	1,765
E 14 C	C_41434EC	600	1,327	1,399	1,563
I 14 C	C_41434IC	780	1,504	1,580	1,749
E 18 C	C_41805EC	1,500	3,244	3,430	3,853
I 18 C	C_41805IC	1,800	3,606	3,801	4,241
E 18	F_41805EC	1,550	3,244	3,430	3,853
I 18	F_41805IC	1,800	3,641	3,837	4,278
E 22/4/7	O_42107EC	1,350	2,920	3,173	3,810
I 22/4/7	O_42107IC	1,480	3,320	3,600	4,330
E 22 C	C_42216EC	2,300	5,066	5,387	6,131
I 22 C	C_42216IC	2,900	6,147	6,506	7,327
E 22	F_42216EC	2,400	5,066	5,387	6,131
I 22	F_42216IC	2,900	6,207	6,568	7,932
E 32 C	C_43208EC	3,200	6,521	6,918	7,834
I 32 C	C_43208IC	3,700	7,321	7,745	8,711
E 32	F_43208EC	3,200	6,521	6,918	7,834
I 32	F_43208IC	3,700	7,321	7,745	8,711
E 36/6/18	O_43618EC		6,678	7,090	8,039
I 36/6/18	O_43618IC		7,303	7,736	8,729

HOW TO ORDER

C R 4 14 34 EC

Shape code ←
 Ferrite core material ←
 Used for all ferrite types ←
 Approximate length in mm ←
 Approximate width in mm ←
 Geometry code ←

SHAPE CODE

C – Planar core with clip recesses
 F or O – Planar core option: no clip recesses
 For clip slot dimensions—see individual data sheets

GEOMETRY CODE

EC – Planar E core
 IC – Planar I core

Cores are sold per piece (for sets multiply by 2).
 Any practical gap available, see page 14.

E CORE

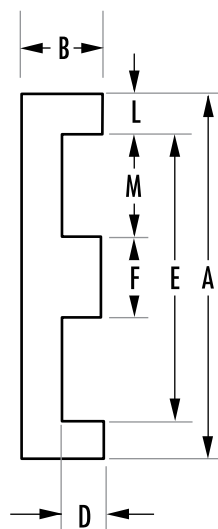

I CORE

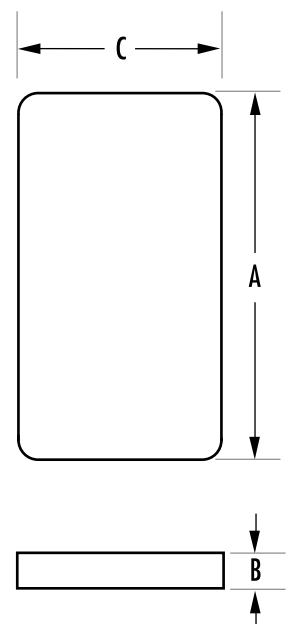



		MAGNETIC DATA						HARDWARE	
TYPE/SIZE	ORDERING CODE	l_e (mm)	A_e (mm ²)	A_{min} (mm ²)	V_e (mm ³)	$WaAc$ (cm ⁴)	Weight (grams per set)	Bobbins	Clips
14/2.5/5	O_41425EC	16.7	14.7	14.7	244	0.01	1.2		
E 14 C	C_41434EC	20.7	14.7	14.7	304	0.02	1.5		
I 14 C	C_41434IC	16.4	14.2	11.4	230	0.008	1.2		✓
E 18 C	C_41805EC	24.2	40.1	39.9	972	0.07	4.8		
I 18 C	C_41805IC	20.3	39.5	35.9	830	0.03	4.1		✓
E 18	F_41805EC	24.2	40.1	39.9	972	0.07	4.8		
I 18	F_41805IC	20.3	40.1	39.9	813	0.03	3.9		
E 22/4/7	O_42107EC	25.7	37.1	36.0	960	0.06	4.2		
I 22/4/7	O_42107IC	22.7	35.7	33.5	809	0.03	3.9		
E 22 C	C_42216EC	32.3	76.0	73.1	2,451	0.27	12.0		
I 22 C	C_42216IC	26.1	80.4	72.5	2,100	0.14	10.4		✓
E 22	F_42216EC	32.5	78.5	76.0	2,550	0.27	12.5		
I 22	F_42216IC	25.8	80.6	80.6	2,080	0.13	10.2		
E 32 C	C_43208EC	41.4	130	130	5,380	0.71	26		
I 32 C	C_43208IC	35.1	130	130	4,560	0.36	22		
E 32	F_43208EC	41.4	130	130	5,380	0.71	26		
I 32	F_43208IC	35.1	130	130	4,560	0.36	22		
E 36/6/18	O_43618EC	42.4	135	135	5,750	0.55	28		
I 36/6/18	O_43618IC	37.4	135	135	5,060	0.27	25		

Refer to page 58 for hardware information.

		DIMENSIONS (mm)							
TYPE/SIZE	ORDERING CODE	A	B	C	D	E	F	L	M
14/2.5/5	O_41425EC	14.0±0.3	2.5±0.1	5.0±0.1	1.0±0.1	11.0±0.25	3.0±0.1	1.5 ref	4.0 ref
E 14 C	C_41434EC	14.0±0.3	3.5±0.1	5.0±0.15	1.91 min	10.5 min	3.0±0.1	1.5 ref	4.0 ref
I 14 C	C_41434IC	14.0±0.3	1.8±0.05	5.0±0.15	1.5±0.1	2.5+0.2/-0			
E 18 C	C_41805EC	18.0±0.35	4.0±0.1	10.0±0.2	2.0±0.1	14±0.3	4.0±0.1	2.0 ref	5.0 ref
I 18 C	C_41805IC	18.0±0.35	2.4±0.5	10.0±0.2	2.0±0.1	2.5+0.2/-0			
E 18	F_41805EC	18.0±0.35	4.0±0.1	10.0±0.2	2.0±0.1	13.7 min	4.0±0.1	2.0 ref	5.0 ref
I 18	F_41805IC	18.0±0.41	2.39±0.1	10.0±0.2					
E 22/4/7	O_42107EC	21.8±0.4	3.91±0.8	7.8±0.5	1.73±0.2	16.8±0.3	5.0±0.2	2.5±0.12	5.89±0.25
I 22/4/7	O_42107IC	21.8±0.4	2.3±0.2	7.8±0.3					
E 22 C	C_42216EC	21.8±0.4	5.7±0.1	15.8±0.3	3.05 min	16.1 min	5.0±0.1	2.5 ref	5.9 ref
I 22 C	C_42216IC	21.8±0.4	2.9±0.05	15.8±0.3	2.5±0.1	2.9+0.2/-0			
E 22	F_42216EC	21.8±0.4	5.72±0.1	15.8±0.3	3.05 min	16.1 min	5.0±0.1	2.5 ref	5.9 ref
I 22	F_42216IC	21.8±0.4	2.95±0.1	15.8±0.3					
E 32 C	C_43208EC	31.75±0.64	6.35±0.13	20.32±0.41	3.18±0.2	24.9 min	6.35±0.13	3.18 ref	9.27 ref
I 32 C	C_43208IC	31.75±0.64	3.18±0.13	20.32±0.41					
E 32	F_43208EC	31.75±0.64	6.35±0.13	20.32±0.41	3.18±0.2	24.9 min	6.35±0.13	3.18 ref	9.27 ref
I 32	F_43208IC	31.75±0.64	3.18±0.13	20.32±0.41					
E 36/6/18	O_43618EC	35.56±0.5	6.35±0.13	17.8±0.4	2.41 min	27.2 min	7.62±0.18	3.81±0.13	10.16±0.25
I 36/6/18	O_43618IC	35.56±0.5	3.68±0.3	17.8±0.4					

Planar E, I Cores

38 mm – 102 mm



TYPE/SIZE	ORDERING CODE	NOMINAL A _L (MH/1000T)				
		L	R	P	F	J
E 38	F_43808EC	3,880	7,618	8,354	9,490	
I 38	F_43808IC	4,600	9,028	9,566	10,801	
E 40/8/10	O_44008EC		4,233	4,504	5,134	7,130
I 40/4/10	O_44008IC		4,744	5,035	5,706	8,026
E 43/8/28	O_44308EC		8,598	9,150	10,432	
I 43/4/28	O_44308IC		9,541	10,130	11,849	
E 43	F_44310EC		8,266	8,803	10,057	
I 43	F_44310IC		9,541	10,130	11,489	
E 58 C	C_45810EC		8,498	9,073	10,427	
I 58 C	C_45810IC		9,821	10,457	11,941	
E 58	F_45810EC		8,498	9,073	10,427	
I 58	F_45810IC		9,821	10,457	11,941	
E 64 C	C_46410EC		14,618	15,599	17,901	
I 64 C	C_46410IC		16,139	17,189	19,639	
E 64	F_46410EC		14,618	15,599	17,901	
I 64	F_46410IC		16,192	17,245	19,699	
E 102	O_49938EC		9,292	9,997	11,697	

HOW TO ORDER

C R 4 64 10 EC

- Shape code ←
- Ferrite core material ←
- Used for all ferrite types ←
- Approximate length in mm ←
- Approximate width in mm ←
- Geometry code ←

SHAPE CODE

C – Planar core with clip recesses
 F or O – Planar core option: no clip recesses
 For clip slot dimensions—see individual data sheets

GEOMETRY CODE

EC – Planar E core
 IC – Planar I core

Cores are sold per piece (for sets multiply by 2).
 Any practical gap available, see page 14.

E CORE

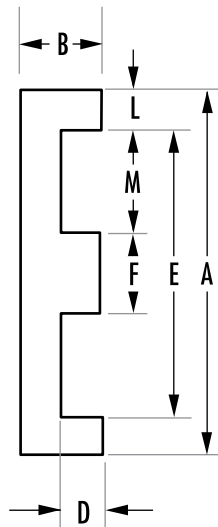

I CORE

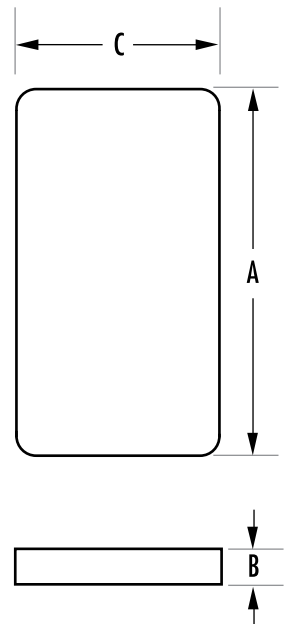



TYPE/SIZE	ORDERING CODE	MAGNETIC DATA						HARDWARE	
		l_e (mm)	A_e (mm ²)	A min (mm ²)	V_e (mm ³)	W_{Ac} (cm ⁴)	Weight (grams per set)	Bobbins	Clips
E 38	F_43808EC	52.4	194	194	10,200	1.88	51		
I 38	F_43808IC	43.7	194	194	8,460	0.94	42		
E 40/8/10	O_44008EC	51.9	101	95.1	5,220	0.77	26		
I 40/4/10	O_44008IC	43.8	99.5	95.1	4,360	0.38	21		
E 43/8/28	O_44308EC	57.5	227	227	13,100	2.52	64		
I 43/4/28	O_44308IC	48.6	227	227	11,000	1.27	54		
E 43	F_44310EC	61.1	229	229	13,900	3.18	71		
I 43	F_44310IC	50.4	229	229	11,500	1.59	58		
E 58 C	C_45810EC	80.6	308	308	24,600	8.16	119		✓
I 58 C	C_45810IC	67.7	310	310	20,800	4.09	101		✓
E 58	F_45810EC	80.6	308	308	24,600	8.16	119		
I 58	F_45810IC	68.3	310	310	20,829	4.09	101		
E 64 C	C_46410EC	80.2	516	516	41,400	11.10	195		✓
I 64 C	C_46410IC	69.9	511	511	35,539	5.52	172		✓
E 64	F_46410EC	80.2	516	516	41,400	11.10	200		
I 64	F_46410IC	69.6	511	511	35,539	5.52	172		
E 102	O_49938EC	148	540	525	79,800	50.5	400		

Refer to page 58 for hardware information.

TYPE/SIZE	ORDERING CODE	DIMENSIONS (mm)							
		A	B	C	D	E	F	L	M
E 38	F_43808EC	38.1 ±0.76	8.26 ±0.13	25.4 ±0.51	4.45 ±0.13	30.23 min	7.62 ±0.15	3.81	11.43
I 38	F_43808IC	38.1 ±0.76	3.81 ±0.13	25.4 ±0.51					
E 40/8/10	O_44008EC	40.65 ±0.5	8.51 ±0.25	10.7 ±0.25	4.06 ±0.25	30.45 ±0.3	10.15 ±0.15	5.1 ref	10.15 ref
I 40/4/10	O_44008IC	40.64 ±0.5	4.45 ±0.25	10.7 ±0.25					
E 43/8/28	O_44308EC	43.2 ±0.5	8.51 ±0.25	27.9 ±0.38	4.19 min	34.4 min	8.13 ±0.13	4.2 nom	13.46 nom
I 43/4/28	O_44308IC	43.2 ±0.9	4.1 ±0.13	27.9 ±0.6					
E 43	F_44310EC	43.2 ±0.9	9.50 ±0.13	27.9 ±0.6	5.4 ±0.13	34.7 min	8.1 ±0.2	4.7 max	13.2 min
I 43	F_44310IC	43.2 ±0.9	4.1 ±0.13	27.9 ±0.6					
E 58 C	C_45810EC	58.42 ±1.2	10.54 ±0.2	38.1 ±0.8	6.35 min	50.0 min	8.1 ±0.2	3.7 ref	21.4 ref
I 58 C	C_45810IC	58.42 ±1.2	4.06 ±0.13	38.1 ±0.8					
E 58	F_45810EC	58.42 ±1.2	10.54 ±0.2	38.1 ±0.8	6.35 min	50.0 min	8.1 ±0.2	3.7 ref	21.4 ref
I 58	F_45810IC	58.42 ±1.2	4.06 ±0.13	38.1 ±0.8					
E 64 C	C_46410EC	64.0 ±0.76	10.2 ±0.1	50.8 ±0.81	5.03 min	53.16 min	10.16 ±0.18	5.08 ±0.12	21.8 ±0.25
I 64 C	C_46410IC	64.0 ±1.27	5.08 ±0.13	50.8 ±1.02					
E 64	F_46410EC	64.0 ±0.76	10.2 ±0.1	50.8 ±0.81	5.03 min	53.16 min	10.16 ±0.18	5.08 ±0.12	21.8 ±0.25
I 64	F_46410IC	64.0 ±1.27	5.08 ±0.13	50.8 ±1.02					
E 102	O_49938EC	102.0 ±1.0	20.3 ±0.25	37.5 ±0.4	13.3 ±0.25	86.0 ±1.0	14.0 ±0.25	8.0 ref	36.0 ref

ER Cores

ER cores are a cross between E cores and pot cores. The round centerpost of the ER core offers minimal winding resistance. In addition, they offer better space utilization and shielding than with rectangular center leg planar cores. When compared with non-planar cores, ERs offer minimal height and better thermal performance.

E/I combinations facilitate economical assembly. Surface mount accessories are available.

Typical applications of ER cores include differential mode inductors and power transformers.

TYPE/SIZE	ORDERING CODE	NOMINAL A_L (MH/1000T)			
		L	R	P	F
ER 9/5	O_40906EC	525	973	1,053	1,270
ER 11/6	O_41126EC	725	1,400	1,690	1,780
ER 12.5/8.5	O_41308EC	950	1,700	1,800	1,950
I 12.5/8.5	O_41308IC	1,000	1,800	1,900	2,000
ER 14.5/6	O_41426EC	850	1,600	1,700	1,850
ER 18/3/10	O_41826EC	1,300	2,623	2,770	3,104
ER 20/7/14	C_42014EC	1,600	3,788	4,026	4,575
I 20/7/14	C_42014IC	2,150	4,500	4,900	5,500
ER 20/7/14	F_42014EC	1,600	3,788	4,026	4,575
I 20/7/14	F_42014IC	2,150	4,479	4,740	5,338
ER 23/3/12	O_42313EC	1,850	3,800	4,030	4,540
ER 25/5.5/18	O_42517EC	3,300	7,021	7,447	8,427
I 25/2/18	O_42517IC				
ER 25/8/18	O_42521EC	2,300	5,440	5,801	6,649
ER 30/8/20	O_43021EC	2,400	5,465	5,841	6,729
I 30/2.5/20	O_43021IC	3,200	6,550	7,784	8,850
ER 32/6/25	O_43225EC		6,950	7,350	8,200

HOW TO ORDER

O R 4 0 9 0 6 E C

Shape code ←
 Ferrite core material ←
 Used for all ferrite types ←
 Approximate length in mm ←
 Approximate depth in mm ←
 Geometry code ←

SHAPE CODE

C – ER core with clip recesses
 F or O – ER core option: no clip recesses

GEOMETRY CODE

EC – ER core
 IC – I core
 For clip slot dimensions see individual data sheets.

ER cores are sold per piece (for sets multiply by 2).
 Any practical gap available. See page 14.

ER CORE

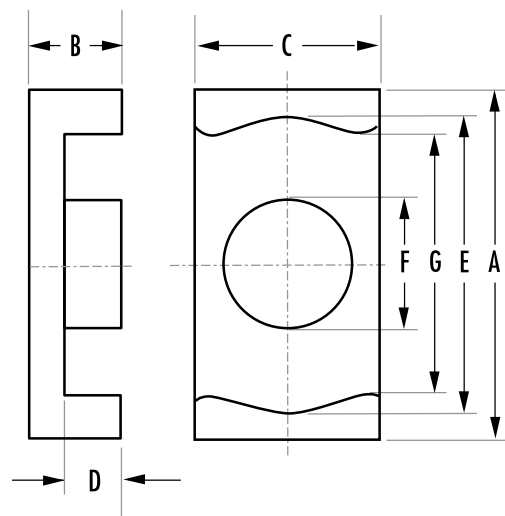

I CORE

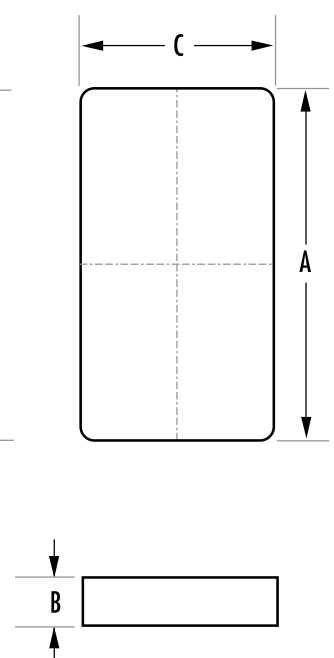

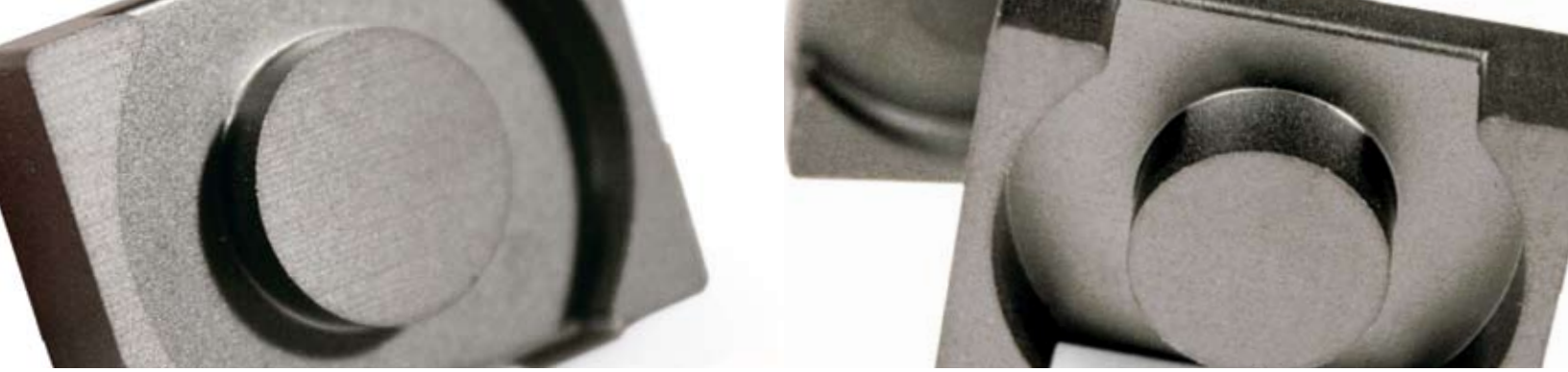

TYPE/SIZE	ORDERING CODE	MAGNETIC DATA						HARDWARE	
		l_e (mm)	A_e (mm ²)	A_{min} (mm ²)	V_e (mm ³)	W_{Ac} (cm ⁴)	Weight (grams per set)	Bobbins	Clips
ER 9/5	O_40906EC	14.2	8.47	7.6	120	0.003	1	✓	✓
ER 11/6	O_41126EC	14.7	11.9	10.3	174	0.004	1		
ER 12.5/8.5	O_41308EC	17.5	19.9	19.2	348	0.011	2		
I 12.5/8.5	O_41308IC	15.9	19.8	19.2	315	0.006	1		
ER 14.5/6	O_41426EC	19.0	17.6	17.3	333	0.011	2		
ER 18/3/10	O_41826EC	22.1	30.2	30.1	667	0.025	3		
ER 20/7/14	C_42014EC	33.2	59.0	55.0	1,960	0.142	10.2		
I 20/7/14	C_42014IC	25.1	59.8	55.0	1,500	0.072	8.0		
ER 20/7/14	F_42014EC	33.2	59.0	55.0	1,960	0.142	10.1		
I 20/7/14	F_42014IC	25.5	57.3	52.5	1,460	0.069	8.0		
ER 23/3/12	O_42313EC	26.6	50.2	50.0	1,340	0.055	6.4		
ER 25/5.5/18	O_42517EC	26.4	89.7	82.8	2,370	0.151	16.4		
I 25/2/18	O_42517IC					0.076	13.1		
ER 25/8/18	O_42521EC	41.4	100	95.0	4,145	0.324	22.0		
ER 30/8/20	O_43021EC	46.0	108	95.0	4,970	0.488	26.4		
I 30/2.5/20	O_43021IC	36.2	108	95.0	3,910	0.244	20.8		
ER 32/6/25	O_43225EC	38.2	141	121	5,400	0.328	27.5		

Refer to page 58 for hardware information.

TYPE/SIZE	ORDERING CODE	DIMENSIONS (mm)						
		A	B	C	D	E	F	G
ER 9/5	O_40906EC	9.5 +0/-0.3	2.45 ± 0.05	5.0 +0/-0.2	1.6 +0.15/0	7.5 +0.4/-0	3.5 +0/-0.2	7.1 +0.35/-0
ER 11/6	O_41126EC	11.0 +0/-0.35	2.45 ± 0.05	6.0 +0/-0.2	1.5 +0.15/0	8.7 +0.3/-0	4.25 +0/-0.25	8.0 +0/-0.25
ER 12.5/8.5	O_41308EC	12.8 ± 0.3	2.85 ± 0.8	8.7 ± 0.25	1.75 ± 0.13	11.2 ± 0.3	5.0 ± 0.15	9.05 ± 0.3
I 12.5/8.5	O_41308IC	12.8 ± 0.3	1.1 ± 0.1	8.7 ± 0.25				
ER 14.5/6	O_41426EC	14.7 +0/-0.4	2.95 ± 0.5	6.8 +0/-0.2	1.55 +0.2/0	11.6 +0.4/-0	4.8 +0/-0.2	
ER 18/3/10	O_41826EC	18.0 ± 0.35	3.15 ± 0.1	9.7 ± 0.2	1.6 ± 0.1	15.6 ± 0.3	6.2 ± 0.15	13.5 min
ER 20/7/14	C_42014EC	20.0 ± 0.35	6.8 ± 0.1	14.0 ± 0.3	4.6 ± 0.15	18 ± 0.35	8.8 ± 0.15	12.86 ± 0.35
I 20/7/14	C_42014IC	20.0 ± 0.35	2.3 ± 0.05	14.0 ± 0.3	1.9 ± 0.1	3.0 ± 0.1		
ER 20/7/14	F_42014EC	20.0 ± 0.35	6.8 ± 0.1	14.0 ± 0.3	4.6 ± 0.15	18.0 ± 0.35	8.8 ± 0.15	12.86 ± 0.35
I 20/7/14	F_42014IC	20.0 ± 0.35	1.9 ± 0.05	14.0 ± 0.3				
ER 23/3/12	O_42313EC	23.2 ± 0.45	3.6 ± 0.1	12.5 ± 0.25	1.6 ± 0.1	20.2 ± 0.4	8.0 ± 0.2	17.5 min
ER 25/5.5/18	O_42517EC	25.0 ± 0.4	5.6 ± 0.1	18.0 ± 0.3	2.75 ± 0.15	22.0 ± 0.4	11.0 ± 0.2	15.2 ± 0.7
I 25/2/18	O_42517IC	25.0 ± 0.4	2.3 ± 0.05	18.0 ± 0.3				
ER 25/8/18	O_42521EC	25.0 ± 0.4	8.0 ± 0.1	18.0 ± 0.3	5.15 ± 0.15	22.0 ± 0.4	11.0 ± 0.2	15.2 ± 0.7
ER 30/8/20	O_43021EC	30.0 ± 0.4	8.0 ± 0.15	20.0 ± 0.3	5.3 ± 0.2	26.0 ± 0.4	11.0 ± 0.2	19.45 ± 0.4
I 30/2.5/20	O_43021IC	30.0 ± 0.4	2.7 ± 0.1	20.0 ± 0.3				
ER 32/6/25	O_43225EC	32.1 +0.55/-0.45	6.0 ± 0.13	25.4 ± 0.4	2.9 +0/-0.25	27.2 ± 0.4	12.4 ± 0.15	27.2 ± 0.4

U, I Cores

U cores are ideal for power transformer applications. The long legs of U core support low leakage inductance designs and facilitate superior voltage isolation. U/I combinations provide for economical assembly.

TYPE/SIZE	ORDERING CODE	NOMINAL A _L (MH/1000T)					
		L	R	P	F	J	W
U 11/4/6	0_41106UC		860	914	1,010	1,662	
I 11/2/6	0_41106IC		960	1,020	1,150	1,687	
U 22/21/6	0_42220UC		893	973	1,360	2,107	3,429
U 25/13/13	0_42512UC		1,907	2,067	2,480	4,400	
U 25/16/6	0_42515UC		1,107	1,333	1,600	2,507	
I 25/6/6	0_42516IC	660	1,480	1,650	1,770	2,907	
U 25/16/12	0_42530UC		2,093	2,280	2,740	4,860	
U 93/76/16	0_49316UC		3,450	3,730	4,110	8,100	
I 93/28/16	0_49316IC		4,600	4,960	5,840	10,500	
U 93/76/30	0_49330UC			7,219			
U 93/76/32	0_49332UC			7,700			
U 126/91/20	0_49920UC		3,000	3,572	4,265	6,967	
U 102/57/25	0_49925UC		4,533	5,500	6,500		
I 102/25/25	0_49925IC		5,707	6,200	7,440		

HOW TO ORDER

O F 4 22 20 UC

Shape code ←

Ferrite core material ←

Used for all ferrite types ←

Approximate length in mm ←

Approximate width in mm ←

Geometry code ←

GEOMETRY CODE

UC – U core

IC – I core

U and I cores are sold per piece (for sets multiply by 2).

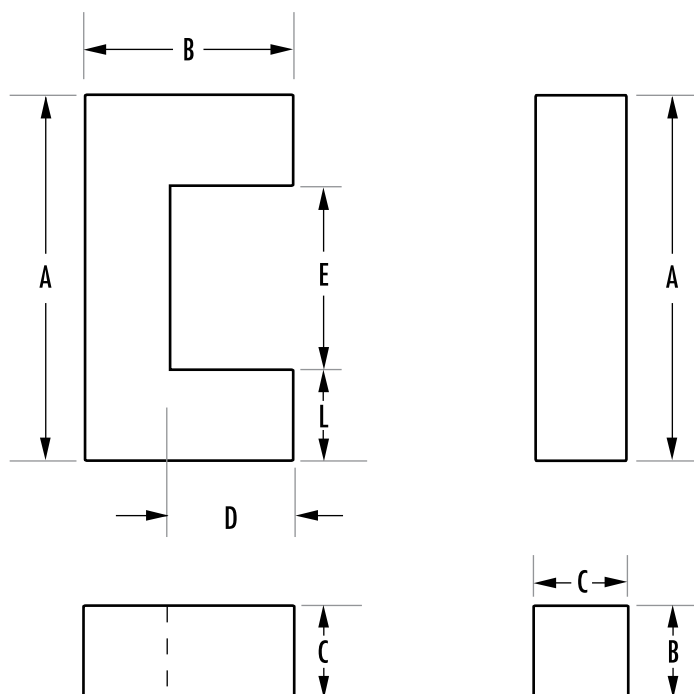

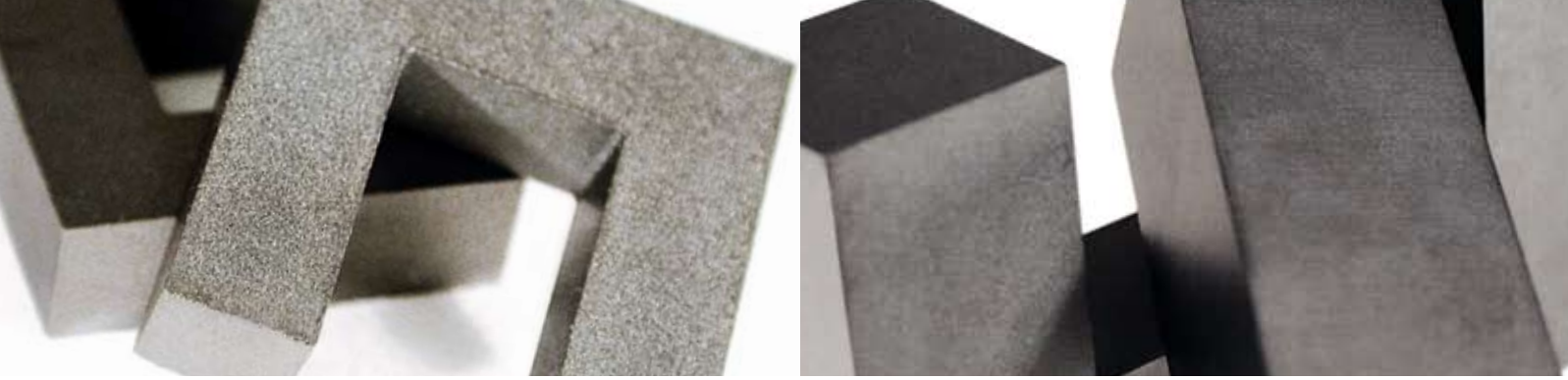

		MAGNETIC DATA						HARDWARE	
TYPE/SIZE	ORDERING CODE	I_e (mm)	A_e (mm ²)	A min (mm ²)	V_e (mm ³)	WaAc (cm ⁴)	Weight (grams per set)	Bobbins	Clips
U 11/4/6	0_41106UC	29.2	12	11.5	350	0.02	1.8		
I 11/2/6	0_41106IC	24.6	11.5	11.5	283	0.01	1.5		
U 22/21/6	0_42220UC	95.8	39.7	39.7	4,130	0.63	19		
U 25/13/13	0_42512UC	68.9	80.0	80.0	4,170	0.78	29		
U 25/16/6	0_42515UC	83.4	40.4	40.4	3,370	0.57	17		
I 25/6/6	0_42516IC	64.3	40.3	40.3	2,590	0.32	13		
U 25/16/12	0_42530UC	83.4	80.8	80.8	6,740	1.13	34		
U 93/76/16	0_49316UC	353	452	452	160,000	91.4	800		
I 93/28/16	0_49316IC	257	450	450	115,000	45.8	600		
U 93/76/30	0_49330UC	354	840	840	297,000	173	1,490		
U 93/76/32	0_49332UC	353	905	896	319,000	185	1,600		
U 126/91/20	0_49920UC	480	560	560	268,800	286	1,360		
U 102/57/25	0_49925UC	308	645	645	199,000	121	988		
I 102/25/25	0_49925IC	245	645	645	158,000	60.7	784		

Refer to page 58 for hardware information.

		DIMENSIONS (mm)					
TYPE/SIZE	ORDERING CODE	A	B	C	D	E	L
U 11/4/6	0_41106UC	10.85 ± 0.2	4.19 ± 0.13	6.3 ± 0.13	2.24 ± 0.13	7.19 ± 0.2	1.83 ± 0.13
I 11/2/6	0_41106IC	10.8 ± 0.2	1.83 ± 0.12	6.3 ± 0.13			
U 22/21/6	0_42220UC	22.1 ± 0.38	20.6 ± 0.38	6.27 ± 0.18	13.98 min	9.5 ± 0.38	6.27 ± 0.18
U 25/13/13	0_42512UC	25.4 ± 0.5	12.9 ± 0.4	12.7 ± 0.4	6.35 min	12.8 ref	6.3 ± 0.13
U 25/16/6	0_42515UC	25.4 ± 0.51	15.9 ref	6.35 ± 0.12	9.27 min	12.7 ref	6.45 ± 0.15
I 25/6/6	0_42516IC	25.4 + 0.64/-0.51	6.35 ± 0.13	6.35 ± 0.13			
U 25/16/12	0_42530UC	25.4 ± 0.51	15.9 ref	12.7 ± 0.25	9.27 min	12.7 ref	6.45 ± 0.15
U 93/76/16	0_49316UC	93.0 ± 1.8	76.0 ± 0.5	16.0 ± 0.6	48.0 ± 0.9	36.2 ± 1.2	28.4 ref
I 93/28/16	0_49316IC	93.0 ± 1.8	27.5 ± 0.5	16.0 ± 0.6			
U 93/76/30	0_49330UC	93.0 ± 1.8	76.0 ± 0.5	30.0 ± 0.6	48.0 ± 0.9	36.2 ± 1.2	28.4 ref
U 93/76/32	0_49332UC	93.0 ± 1.8	76.0 ± 0.5	32.0 ± 0.6	48.0 ± 0.9	36.2 ± 1.2	28.4 ref
U 126/91/20	0_49920UC	126.0 ± 4.0	91.0 ± 1.0	20.0 ± 0.6	63.0 ± 2.0	70.0 ± 2.0	28.0 ref
U 102/57/25	0_49925UC	101.6 ± 1.5	57.1 ± 0.4	25.4 ± 0.6	31.7 ± 0.75	50.8 ± 1	25.4 ± 0.8
I 102/25/25	0_49925IC	101.6 ± 1.5	25.4 ± 0.4	25.4 ± 0.6			

UR Cores

UR cores are an excellent choice for high current designs and conditions where vibration occurs. The open window area accommodates large conductors. Holes through the center, or grooves on the outer legs of the core provide a method to secure the core to the PCB with mounting hardware.

Typical applications include: the output transformer application in welding, audio amplifiers, traction and other high-power designs.

TYPE/SIZE	ORDERING CODE	NOMINAL A_L (MH/1000T)		
		R	P	F
UR 41/21/11	0_44119UC	1,627	1,773	2,130
UR 41/21	0_44121UC	1,880	2,047	2,465
UR 41/25	0_44125UC	1,600	1,747	2,105
UR 41/30	0_44130UC	1,400	1,520	1,830
UR 57	0_45716UC	2,600	3,061	3,622
UR 59	0_45917UC	3,027	3,274	3,881
UR 64	0_46420UC	3,787	4,098	4,864

HOW TO ORDER

OP 44125 UC

- Shape code ←
- Ferrite core material ←
- Used for all ferrite types ←
- Approximate length in mm ←
- Approximate depth in mm ←
- Geometry code ←

UR cores are sold per piece (for sets multiply by 2).
For UR 64 size, refer to datasheets for drawings.

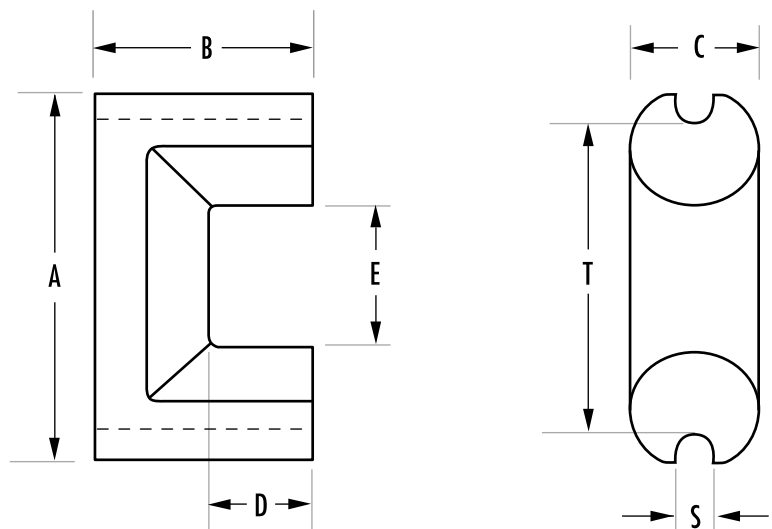

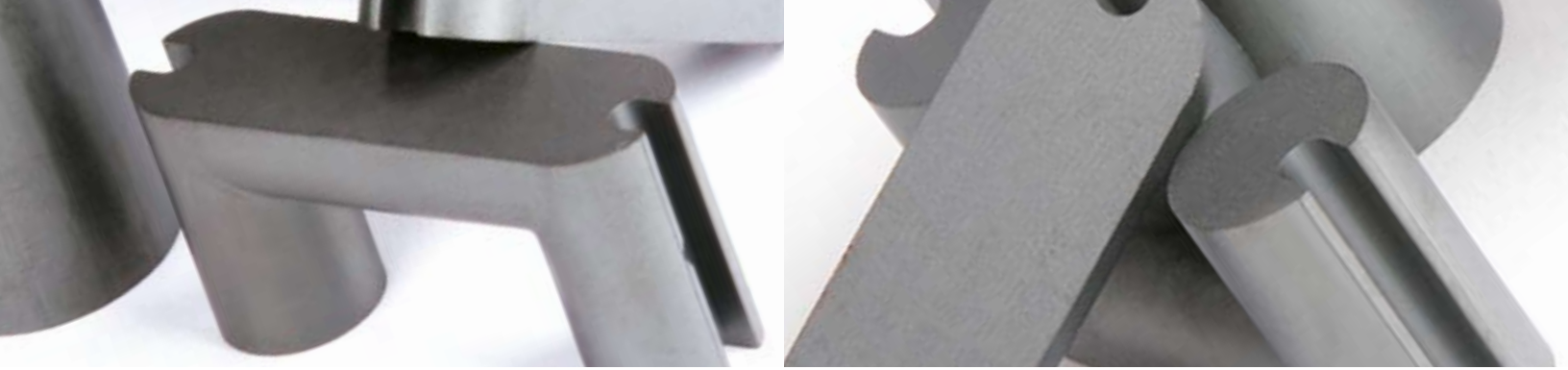

TYPE/SIZE	ORDERING CODE	MAGNETIC DATA						HARDWARE	
		l_e (mm)	A_e (mm ²)	A min (mm ²)	V_e (mm ³)	WaAc (cm ⁴)	Weight (grams per set)	Bobbins	Clips
UR 41/21/11	0_44119UC	121.2	91.1	80.5	11,000	2.75	54	✓	✓
UR 41/21	0_44121UC	113	104	84.0	11,800	2.81	55		
UR 41/25	0_44125UC	134.4	113.1	105.4	15,196	4.0	64		
UR 41/30	0_44130UC	154.8	112.1	105.4	17,346	5.25	75		
UR 57	0_45716UC	163	171	171	27,900	8.84	140		
UR 59	0_45917UC	189	210	210	39,700	13.8	198		
UR 64	0_46420UC	210	290	290	61,000	21.9	320		

Refer to page 58 for hardware information.

TYPE/SIZE	ORDERING CODE	DIMENSIONS (mm)						
		A	B	C	D	E	S	T
UR 41/21/11	0_44119UC	41.78 ± 0.81	20.9 ± 0.12	11.94 ± 0.25	13.4 min	18.8 ± 0.56	3.18 nom	34.66 ref
UR 41/21	0_44121UC	41.78 ± 0.81	20.62 ± 0.13	11.94 ± 0.25	11.1 ± 0.2	18.8 ± 0.56	3.18 ± 0.13	34.66 nom
UR 41/25	0_44125UC	41.78 ± 0.81	25.4 ± 0.13	11.94 ± 0.25	15.9 ± 0.2	18.8 ± 0.56	3.18 ± 0.13	34.66 nom
UR 41/30	0_44130UC	41.78 ± 0.81	30.5 ± 0.3	11.94 ± 0.25	20.8 min	18.8 ± 0.56	3.18 ± 0.13	34.66 ref
UR 57	0_45716UC	57.65 ± 1.7	28.6 + 0/-0.4	15.9 ± 0.4	15.5 + 1/-0	27.8 ± 0.9	4.8 ± 0.2	49.8 ± 0.8
UR 59	0_45917UC	59.34 ± 1.75	35.8 ± 0.4	17.0 ± 0.4	21.5 ± 0.8	26.5 ± 0.1	4.5 ± 0.2	50.5 ± 0.1
UR 64	0_46420UC	64.0 ± 1.95	40.5 ± 0.2	24.0 ± 0.3	26.5 ± 0.4	24.1 ± 0.9	4.0 min	44.0 ± 0.6

EC Cores

A cross between a pot core and an E core, EC cores have a round center post that provides a wide opening on each side, and therefore, minimum winding resistance. The long legs support low leakage inductance designs.

EC cores have standard channels for clamping assemblies. Plain bobbins, printed circuit bobbins and clamps are available for most sizes.

Magnetics EC cores are typically used in differential mode inductor and power transformer applications.

TYPE/SIZE	ORDERING CODE	NOMINAL A_L (MH/1000T)		
		R	P	F
EC 35	0_43517EC	2,213	2,400	3,000
EC 41	0_44119EC	2,947	3,200	3,700
EC 52	0_45224EC	3,867	4,200	5,040
EC 70	0_47035EC	4,413	4,800	5,760

HOW TO ORDER

OR 47035 EC

- Shape code ←
- Ferrite core material ←
- Used for all ferrite types ←
- Approximate length in mm ←
- Approximate width in mm ←
- Geometry code ←

EC cores are sold per piece (for sets multiply by 2).
Any practical gap available. See page 14.

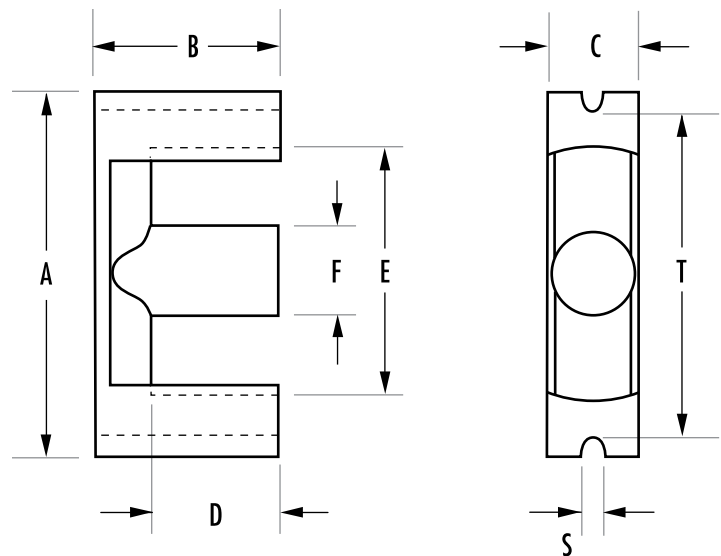

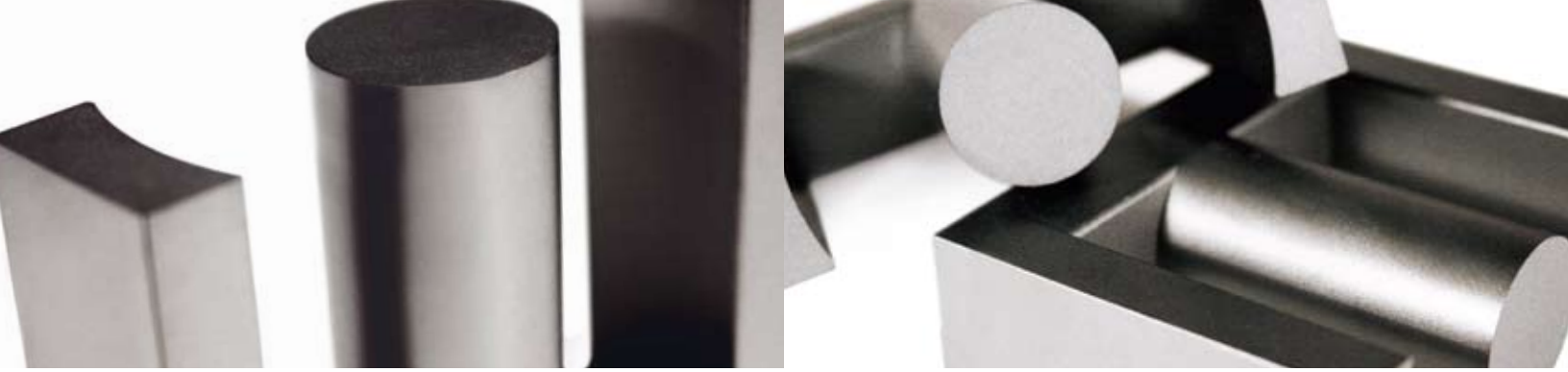

TYPE/SIZE	ORDERING CODE	MAGNETIC DATA						HARDWARE	
		l_e (mm)	A_e (mm ²)	A min (mm ²)	V_e (mm ³)	WaAc (cm ⁴)	Weight (grams per set)	Bobbins	Clips
EC 35	0_43517EC	77.4	84.3	71	6,530	0.83	36	✓	✓
EC 41	0_44119EC	89.3	121	106	10,800	1.67	60	✓	✓
EC 52	0_45224EC	105	180	141	18,800	3.87	111	✓	✓
EC 70	0_47035EC	144	279	211	40,100	13.4	253	✓	✓

Refer to page 58 for hardware information.

TYPE/SIZE	ORDERING CODE	DIMENSIONS (mm)							
		A	B	C	D	E	F	S	T
EC 35	0_43517EC	34.5 ± 0.8	17.3 ± 0.15	9.5 ± 0.3	12.3 ± 0.4	22.75 ± 0.55	9.5 ± 0.3	2.75 ± 0.25	28.5 ± 0.8
EC 41	0_44119EC	40.6 ± 1.0	19.5 ± 0.15	11.6 ± 0.3	13.9 ± 0.4	27.7 ± 0.7	11.6 ± 0.3	3.25 ± 0.25	33.6 ± 1
EC 52	0_45224EC	52.2 ± 1.3	24.2 ± 0.15	13.4 ± 0.35	15.9 ± 0.4	33.0 ± 0.9	13.4 ± 0.35	3.75 ± 0.25	44.0 ± 1.3
EC 70	0_47035EC	70.0 ± 1.7	34.5 ± 0.15	16.4 ± 0.4	22.75 ± 0.45	44.5 ± 1.2	16.4 ± 0.4	4.75 ± 0.25	59.6 ± 1.7

EER Cores

EER cores are an economical choice for transformers and inductors. The round centerpost offers the advantage of a shorter winding path length than winding around a square centerpost of equal area.

Differential mode inductors and power transformers are typical applications for Magnetics EER cores.

TYPE/SIZE	ORDERING CODE	NOMINAL A_L (MH/1000T)			
		L	R	P	F
EER 28/14/11	0_42814EC	1,340	2,700	3,352	3,896
EER 28/16/11	0_42817EC	1,150	2,500	2,913	3,400
EER 35L	0_43521EC		2,693	2,960	3,550
EER 40/22/13	0_44013EC		3,300	3,520	4,000
EER 42	0_44216EC		3,840	4,173	5,000
EER 48/18/17	0_44818EC		6,400	6,850	7,950
EER 48/21/21	0_44821EC		5,700	7,059	8,274
EER 53/18/18	0_45418EC		6,100	6,500	7,440

HOW TO ORDER

OR 44216 EC

- Shape code ←
- Ferrite core material ←
- Used for all ferrite types ←
- Approximate length in mm ←
- Approximate height or width in mm ←
- Geometry code ←

EER cores are sold per piece (for sets multiply by 2).
Any practical gap available, see page 14.

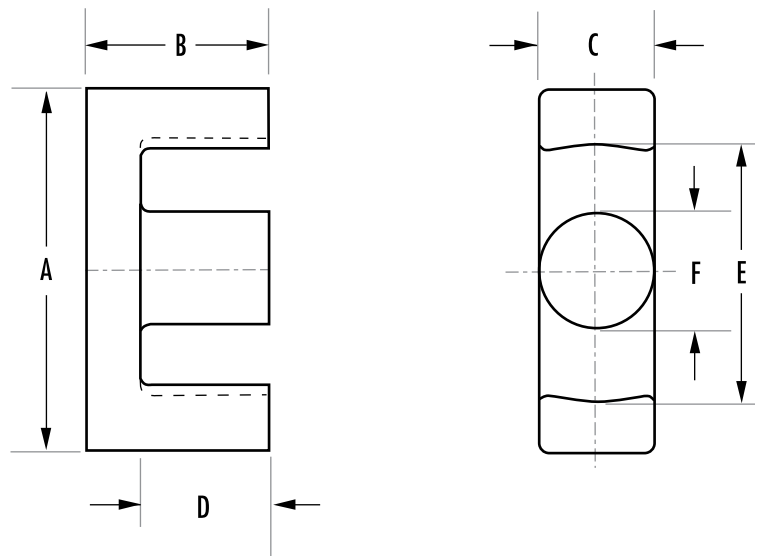

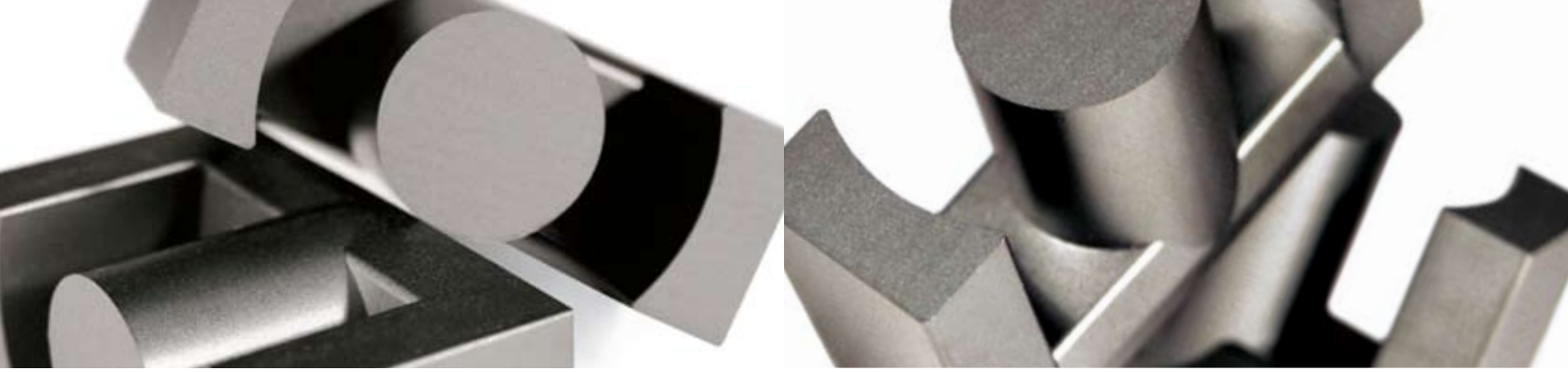

		MAGNETIC DATA						HARDWARE	
TYPE/SIZE	ORDERING CODE	l_e (mm)	A_e (mm ²)	A min (mm ²)	V_e (mm ³)	WaAc (cm ⁴)	Weight (grams per set)	Bobbins	Clips
EER 28/14/11	0_42814EC	64.0	81.4	77.0	5,260	0.532	28		
EER 28/16/11	0_42817EC	75.5	81.4	77.0	6,142	0.693	32		
EER 35L	0_43521EC	90.8	107	100	9,710	1.58	49	✓	
EER 40/22/13	0_44013EC	98.0	149	139	14,600	2.16	74		
EER 42	0_44216EC	98.7	175	166	17,300	2.98	106	✓	
EER 48/18/17	0_44818EC	86.0	232	223	19,900	2.93	102		
EER 48/21/21	0_44821EC	100	255	248	25,500	4.43	128		
EER 53/18/18	0_45418EC	91.8	250	240	23,000	3.61	122		

Refer to page 58 for hardware information.

		DIMENSIONS (mm)					
TYPE/SIZE	ORDERING CODE	A	B	C	D	E	F
EER 28/14/11	0_42814EC	28.55 ± 0.55	14 ± 0.2	11.4 ± 0.35	9.75 ± 0.4	21.75 ± 0.5	9.9 ± 0.25
EER 28/16/11	0_42817EC	28.55 ± 0.55	16.7 ± 0.25	11.4 ± 0.35	12.65 ± 0.4	21.75 ± 0.5	9.9 ± 0.25
EER 35L	0_43521EC	35.0 ± 0.65	20.7 ± 0.2	11.4 ± 0.35	14.75 ± 0.35	26.15 ± 0.55	11.3 ± 0.25
EER 40/22/13	0_44013EC	40.0 ± 0.7	22.4 ± 0.2	13.4 ± 0.35	15.45 ± 0.35	29.6 ± 0.6	13.3 ± 0.25
EER 42	0_44216EC	42.15 ± 0.85	21.0 ± 0.2	14.7 ± 0.3	15.6 min	31.0 ± 0.6	14.7 ± 0.3
EER 48/18/17	0_44818EC	48.0 ± 1.0	18.0 ± 0.2	17.6 ± 0.4	11.45 ± 0.25	36.8 ± 0.8	17.6 ± 0.4
EER 48/21/21	0_44821EC	48.0 ± 1.0	21.2 +0/-0.4	21 + 0.3/-0.5	14.7 + 0.7/-0	38 + 0.5/-0.8	18.0 ± 0.3
EER 53/18/18	0_45418EC	53.5 ± 1.0	18.3 ± 0.2	17.95 ± 0.35	11.1 ± 0.3	40.65 ± 0.85	17.9 ± 0.4

EFD Cores

The industry standard flat design of EFD cores offers excellent space utilization for transformers or inductors. The optimized cross-sectional area is ideal for very flat compact transformer applications.

EFD cores are designed for compact transformers and inductor applications.

TYPE/SIZE	ORDERING CODE	NOMINAL A_L (MH/1000T)					
		L	R	P	F	T	J
EFD 10	0_41009EC	280	585	622	698		923
EFD 12	0_41212EC	380	760	800	844		2,600
EFD 15	0_41515EC	400	893	973	1,170	1,140	1,933
EFD 20	0_42019EC	650	1,300	1,633	1,881	1,540	2,696
EFD 25	0_42523EC	1,000	2,093	2,280	2,730	2,660	4,507
EFD 30	0_43030EC	1,000	2,200	2,695	3,137	2,520	4,668

HOW TO ORDER

OR 4 15 15 EC

- Shape code ←
- Ferrite core material ←
- Used for all ferrite types ←
- Approximate length in mm ←
- Approximate width (per set) in mm ←
- Geometry code ←

EFD cores are sold per piece (for sets multiply by 2).
Any practical gap available. See page 14.

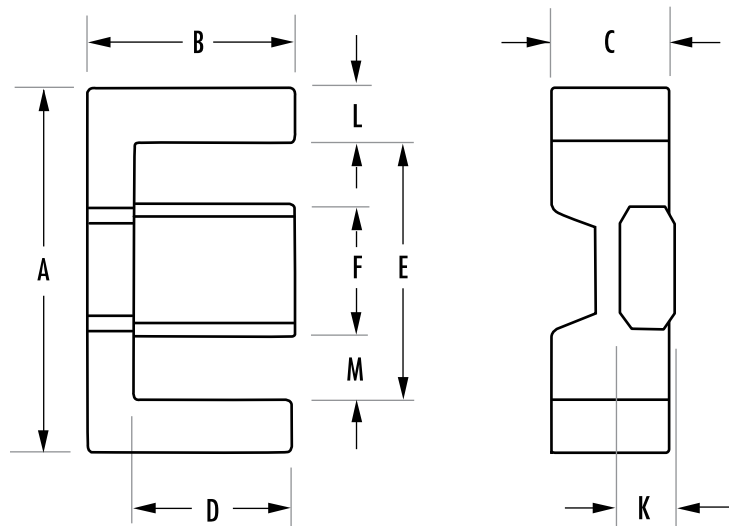

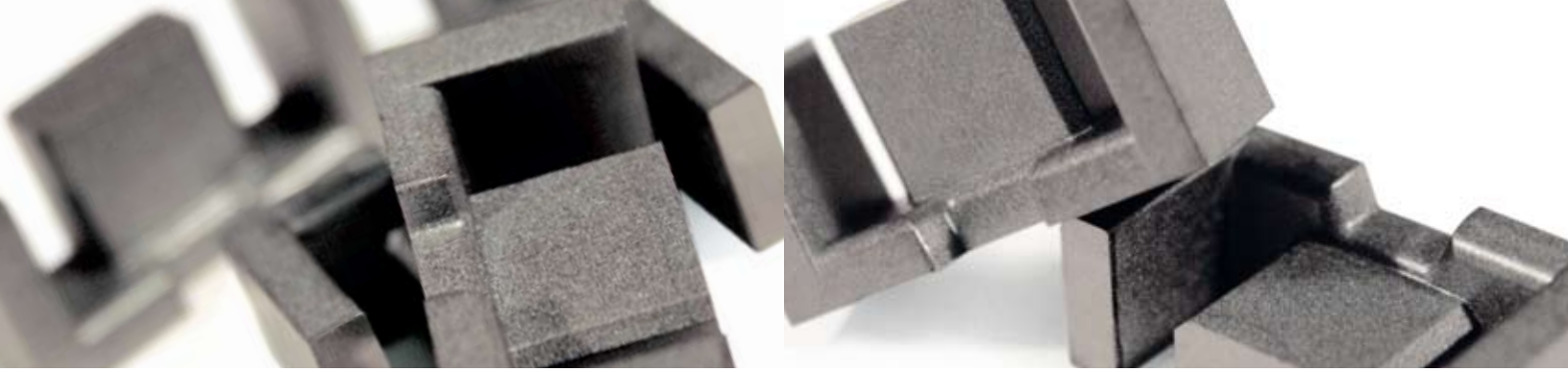

TYPE/SIZE	ORDERING CODE	MAGNETIC DATA						HARDWARE	
		l_e (mm)	A_e (mm ²)	A_{min} (mm ²)	V_e (mm ³)	$WaAc$ (cm ⁴)	Weight (grams per set)	Bobbins	Clips
EFD 10	0_41009EC	23.7	7.2	6.5	171	0.004	0.9	✓	✓
EFD 12	0_41212EC	28.5	11.4	10.7	325	0.01	1.8	✓	✓
EFD 15	0_41515EC	34.0	15.0	12.2	510	0.02	2.8	✓	✓
EFD 20	0_42019EC	47.0	31.0	29.0	1,460	0.09	7.0	✓	✓
EFD 25	0_42523EC	57.0	58.0	55.0	3,300	0.24	16.2	✓	✓
EFD 30	0_43030EC	68.0	69.0	66.0	4,700	0.34	24.0	✓	✓

Refer to page 58 for hardware information.

TYPE/SIZE	ORDERING CODE	DIMENSIONS (mm)								
		A	B	C	D	E	F	K	L	M
EFD 10	0_41009EC	10.5 ± 0.3	5.2 ± 0.1	2.7 ± 0.1	3.75 ± 0.15	7.65 ± 0.25	4.55 ± 0.15	4.45 ± 0.05	1.43 ref	1.55 ref
EFD 12	0_41212EC	12.5 ± 0.3	6.2 ± 0.1	3.5 ± 0.1	4.55 ± 0.15	9.0 ± 0.25	5.4 ± 0.15	2.0 ± 0.1	1.75 ref	1.8 ref
EFD 15	0_41515EC	15.0 ± 0.4	7.5 ± 0.15	4.65 ± 0.15	5.5 ± 0.25	11.0 ± 0.35	5.3 ± 0.15	2.4 ± 0.1	2.0 nom	2.85 nom
EFD 20	0_42019EC	20.0 ± 0.55	10.0 ± 0.15	6.65 ± 0.15	7.7 ± 0.25	15.4 ± 0.5	8.9 ± 0.2	3.6 ± 0.15	2.3 ref	3.25 ref
EFD 25	0_42523EC	25.0 ± 0.66	12.5 ± 0.15	9.1 ± 0.2	9.05 min	18.1 min	11.4 ± 0.2	5.2 ± 0.15	3.15 ± 0.2	3.65 ± 0.2
EFD 30	0_43030EC	30.0 ± 0.8	15.0 ± 0.15	9.1 ± 0.2	11.2 ± 0.3	22.4 ± 0.75	14.6 ± 0.25	4.9 ± 0.15	3.8 ref	3.9 ref

ETD Cores

ETD cores are an economical choice for transformers or inductors. ETDs offer a round centerpost for minimum winding resistance. Dimensions are optimized for power transformer efficiency.

Hardware accessories are available.

Typical applications of Magnetics ETD cores include differential mode inductors and power transformers.

TYPE/SIZE	ORDERING CODE	NOMINAL A_L (MH/1000T)			
		L	R	P	F
ETD 29	0_42929EC	1,100	2,250	2,843	3,316
ETD 34	0_43434EC		2,707	2,933	3,600
ETD 39	0_43939EC		2,973	3,227	4,050
ETD 44	0_44444EC		3,667	4,000	4,950
ETD 49	0_44949EC		4,093	4,440	5,400
ETD 54	0_45454EC		5,200	6,281	7,400
ETD 59	0_45959EC		5,747	6,240	7,500

HOW TO ORDER

OR 4 39 39 EC

- Shape code ←
- Ferrite core material ←
- Used for all ferrite types ←
- Approximate length in mm ←
- Approximate height (per set) in mm ←
- Geometry code ←

ETD cores are sold per piece (for sets multiply by 2.)
Any practical gap available. See page 14.

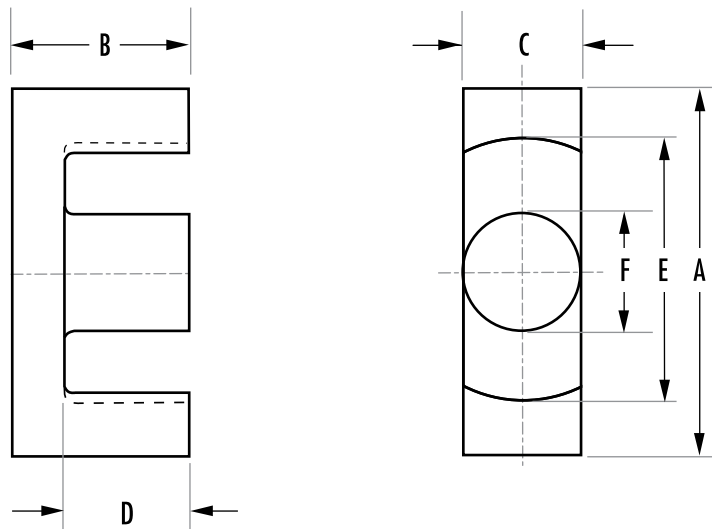

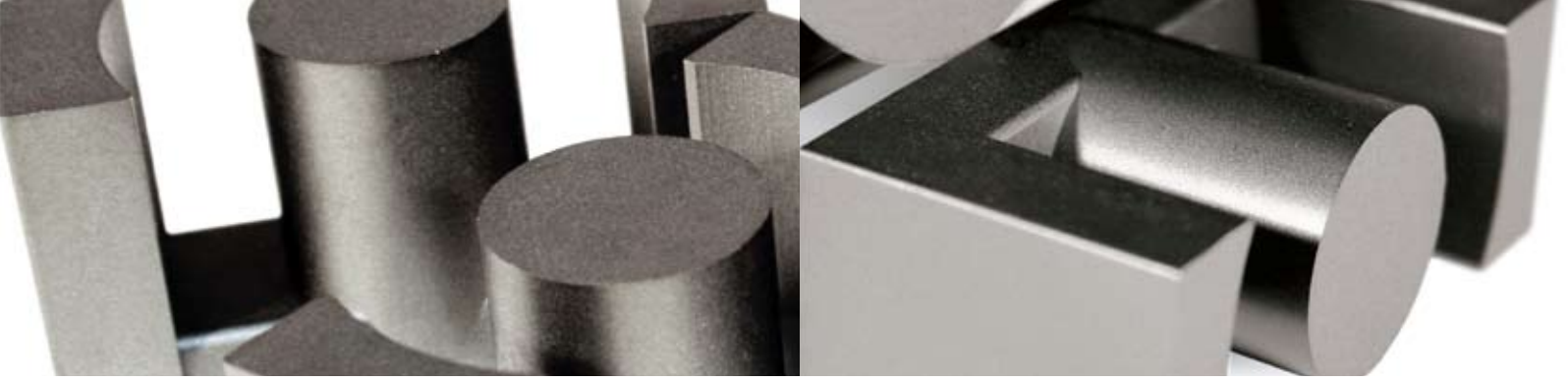

TYPE/SIZE	ORDERING CODE	MAGNETIC DATA						HARDWARE	
		l_e (mm)	A_e (mm ²)	A min (mm ²)	V_e (mm ³)	WaAc (cm ⁴)	Weight (grams per set)	Bobbins	Clips
ETD 29	0_42929EC	72.0	76.0	71.0	5,470	0.71	28	✓	✓
ETD 34	0_43434EC	78.6	97.1	91.6	7,640	1.19	40	✓	✓
ETD 39	0_43939EC	92.2	125	123	11,500	2.18	60	✓	✓
ETD 44	0_44444EC	103	173	172	17,800	3.68	94	✓	✓
ETD 49	0_44949EC	114	211	209	24,000	5.72	124	✓	✓
ETD 54	0_45454EC	127	280	280	35,500	8.88	180	✓	✓
ETD 59	0_45959EC	139	368	360	51,500	13.7	248	✓	✓

Refer to page 58 for hardware information.

TYPE/SIZE	ORDERING CODE	DIMENSIONS (mm)					
		A	B	C	D	E	F
ETD 29	0_42929EC	30.6 +0/-1.6	15.8 ± 0.2	9.8 +0/-0.6	11.0 ± 0.3	22.0 +1.4/0	9.8 +0/-0.6
ETD 34	0_43434EC	35.0 +0/-1.6	17.3 ± 0.2	11.1 +0/-0.6	11.8 +0.6/0	25.6 +1.4/0	11.1 +0/-0.6
ETD 39	0_43939EC	40.0 +0/-1.8	19.8 ± 0.2	12.8 +0/-0.6	14.2 +0.8/0	29.3 +1.6/0	12.8 +0/-0.6
ETD 44	0_44444EC	45.0 +0/-2.0	22.3 ± 0.2	15.2 +0/-0.6	16.1 +0.8/0	32.5 +1.6/0	15.2 +0/-0.6
ETD 49	0_44949EC	49.8 +0/-2.2	24.7 ± 0.2	16.7 +0/-0.6	17.7 +0.8/0	36.1 +1.8/0	16.7 +0/-0.6
ETD 54	0_45454EC	54.5 ± 1.3	27.6 ± 0.2	18.9 ± 0.4	20.2 ± 0.4	41.2 ± 1.1	18.9 ± 0.4
ETD 59	0_45959EC	59.8 ± 1.3	31.0 ± 0.2	21.65 ± 0.45	22.1 min	44.7 ± 1.09	21.65 ± 0.45

Block Cores

Ferrites can be pressed in block form and then machined into intricate shapes. Where large sizes are required, it is possible to assemble them from two or more smaller machined or pressed sections; the variety of sizes and shapes becomes limitless.

Features of Magnetics ferrite blocks include, low porosity, extreme hardness, uniform physical properties, high density and ease of machining. J material offers high permeability; R material is suitable for power applications.

TYPE/SIZE	ORDERING CODE	AVAILABLE MATERIALS				
		L	R	P	F	J
I 11/4/6	O_41106IC		✓	✓	✓	✓
I 25/3/6	O_42515IC	✓	✓	✓	✓	✓
I 25/6/6	O_42516IC	✓	✓	✓	✓	✓
I 38	F_43808IC	✓	✓	✓	✓	
I 43/6/15	O_44020IC		✓	✓		
I 43/4/28	O_44308IC		✓	✓	✓	
I 58	F_45810IC		✓	✓	✓	
I 64	F_46410IC		✓	✓	✓	
I 93/28/16	O_49316IC		✓	✓	✓	✓
I 102/25/25	O_49925IC		✓	✓	✓	
FB 104/66/18	O_49966FB		✓	✓		✓
FB 100/85/25	O_49985FB		✓			

HOW TO ORDER

O R 4 99 66 FB

- Shape code ←
- Ferrite core material ←
- Used for all ferrite types ←
- Approximate length in mm ←
- Approximate height in mm ←
- Geometry code ←

Block cores and I cores are sold per piece.

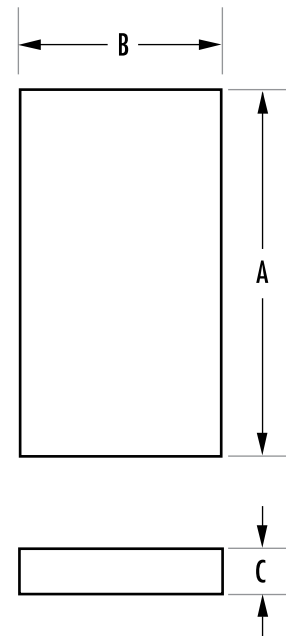



TYPE/SIZE	ORDERING CODE	MAGNETIC DATA		HARDWARE	
		V _e (mm ³)	Weight (grams each)	Bobbins	Clips
111/4/6	O_41106IC	108	0.6		
125/3/6	O_42515IC	445	2.5		
125/6/6	O_42516IC	905	4.5		
138	F_43808IC	3,360	17.0		
143/6/15	O_44020IC	3,250	16.5		
143/4/28	O_44308IC	4,450	22.0		
158	F_45810IC	8,529	41.5		
164	F_46410IC	14,839	72.0		
193/28/16	O_49316IC	35,500	200		
1102/25/25	O_49925IC	59,500	290		
FB 104/66/18	O_49966FB	114,235	600		
FB 100/85/25	O_49985FB	194,310	1020		

Refer to page 58 for hardware information.

TYPE/SIZE	ORDERING CODE	DIMENSIONS (mm)		
		A	B	C
111/4/6	O_41106IC	10.8 ± 0.2	1.83 ± 0.12	6.3 ± 0.13
125/3/6	O_42515IC	25.4 ± 0.38	3.18 ± 0.12	6.35 ± 0.25
125/6/6	O_42516IC	25.4 + 0.64/-0.51	6.35 ± 0.13	6.35 ± 0.13
138	F_43808IC	38.1 ± 0.76	3.81 ± 0.13	25.4 ± 0.51
143/6/15	O_44020IC	43.0 + 0/-1.7	5.9 ± 0.2	15.2 + 0/-0.6
143/4/28	O_44308IC	43.2 ± 0.9	4.1 ± 0.13	27.9 ± 0.6
158	F_45810IC	58.42 ± 1.2	4.06 ± 0.12	38.1 ± 0.8
164	F_46410IC	64.0 ± 1.27	5.08 ± 0.13	50.8 ± 1.02
193/28/16	O_49316IC	93.0 ± 1.8	27.5 ± 0.5	16.0 ± 0.6
1102/25/25	O_49925IC	101.6 ± 1.5	25.4 ± 0.4	25.4 ± 0.6
1104/66/18	O_49966FB	104.0 ± 2	66.0 ± 1.5	18.5 ± 0.4
1100/85/25	O_49985FB	100.0 ± 2	85.0 ± 2	25.4 ± 0.5

EP Cores

EP cores are round center-post cubical shapes which enclose the coil completely except for the printed circuit board terminals. This particular shape minimizes the effect of air gaps formed at mating surfaces in the magnetic path and provides a larger volume ratio to total space used. EP cores provide excellent shielding.

Printed circuit bobbins, surface mount bobbins and mounting clamp assemblies are available.

Typical applications for EP cores include differential mode and telecom inductors and power transformers.

TYPE/SIZE	ORDERING CODE	NOMINAL A_L (MH/1000T)						
		L	R	P	F	T	J	W
EP 7	P_40707UG	590	1,080	1,173	1,240		2,573	5,143
EP 10	P_41010UG	530	1,040	1,133	1,200	1,360	2,467	4,800
EP 13	P_41313UG	760	1,533	1,667	2,000	2,000	3,733	7,143
EP 17	P_41717UG	1,120	2,387	2,600	3,100	3,100	5,867	11,429
EP 20	P_42120UG	1,930	4,227	4,600	5,000	5,000	9,600	19,286

HOW TO ORDER

P J 4 10 10 UG

Shape code ←
 Ferrite core material ←
 Used for all ferrite types ←
 Approximate length in mm ←
 Approximate height (per set) in mm ←
 Geometry code ←

EP cores are sold in sets.
 Any practical gap available. See page 15.

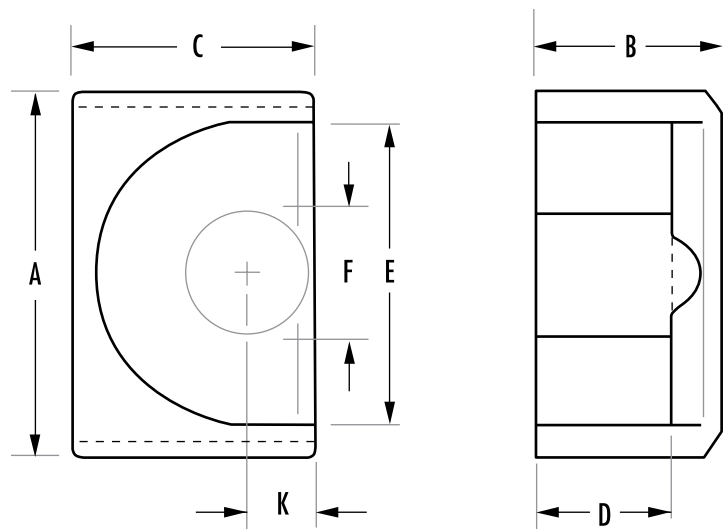

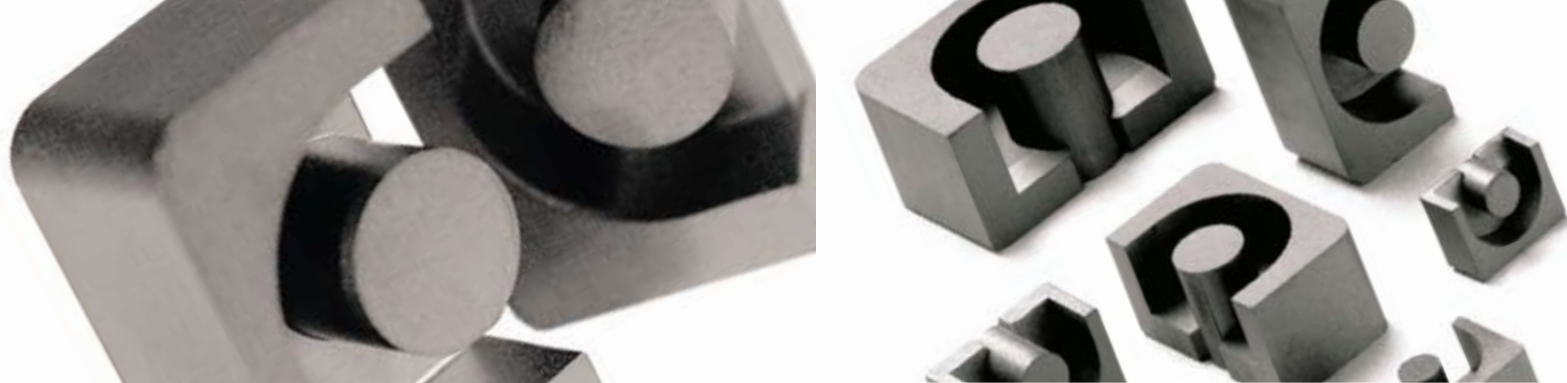

TYPE/SIZE	ORDERING CODE	MAGNETIC DATA						HARDWARE	
		l_e (mm)	A_e (mm ²)	A min (mm ²)	V_e (mm ³)	WaAc (cm ⁴)	Weight (grams per set)	Bobbins	Clips
EP 7	P_40707UG	15.5	10.7	8.55	165	0.005	1.4	✓	✓
EP 10	P_41010UG	19.3	11.3	8.55	215	0.01	2.8	✓	✓
EP 13	P_41313UG	24.2	19.5	14.9	472	0.03	5.1	✓	✓
EP 17	P_41717UG	29.5	33.7	25.5	999	0.06	11.6	✓	✓
EP 20	P_42120UG	41.1	78.7	60.8	3,230	0.24	27.6	✓	✓

Refer to page 58 for hardware information.

TYPE/SIZE	ORDERING CODE	DIMENSIONS (mm)								
		A	B	2B	C	D	2D	E	F	K
EP 7	P_40707UG	9.2±0.2	3.7±0.5	7.4±0.1	6.35±0.15	2.5 min	5.0 min	7.2 min	3.4 max	1.7±0.1
EP 10	P_41010UG	11.5±0.3	5.15±0.1	10.3±0.2	7.6±0.2	3.6 min	7.2 min	9.2 min	3.45 max	1.85±0.1
EP 13	P_41313UG	12.8+0/-0.6	6.45±0.08	12.9±0.16	9.0+0/-0.4	4.5+0.2/-0	9.0+0.4/-0	9.7+0.6/-0	4.5+0/-0.3	2.4±0.1
EP 17	P_41717UG	18.0±0.4	8.4±0.1	16.8±0.2	11.0±0.25	5.7±0.15	11.4±0.3	12.0±0.4	5.7±0.18	3.3±0.2
EP 20	P_42120UG	24.0±0.5	10.7±0.1	21.4±0.2	15.0±0.35	7.2±0.15	14.4±0.3	16.5±0.4	8.8±0.25	4.5±0.2

Pot Cores

The pot core shape is a convenient means of adjusting the ferrite structure to meet the specific requirements of an application. Both high circuit Q and good temperature stability of inductance can be obtained with these cores. Pot cores, when assembled, nearly surround the wound bobbin. This self-shielded geometry isolates the winding from stray magnetic fields or effects from other surrounding circuit elements.

Typical applications for pot cores include; differential mode inductors, power transformers, power inductors, converter and inverter transformers, filters, both broadband and narrow, transformers and telecom inductors.

TYPE/SIZE	ORDERING CODE	NOMINAL A_L (MH/1000T)								
		R	P	F	T	J	W	C	E	V
PC 7/4	0_40704UG	886	964	1,200		2,257	4,286		900	950
PC 9/5	0_40905UG	1,013	1,100	1,365		2,727	6,029	640		
PC 11/7	0_41107UG	1,533	1,667	2,000		3,900	7,666	800	1,650	1,800
PC 11/9	0_41109UG	1,467	1,573	1,900						
PC 14/8	0_41408UG	2,053	2,240	2,800	2,800	5,073	8,400	1,100	2,100	2,240
PC 18/11	0_41811UG	3,067	3,333	4,000		7,500	12,000	1,400	3,000	3,650
PC 18/14	0_41814UG	3,076	3,268	3,350		5,088				
PC 22/13	0_42213UG	4,040	4,400	4,900	5,200	9,100	16,000	1,700	3,900	4,650
PC 26/16	0_42616UG	5,213	5,667	6,350		11,700	20,000			6,000
PC 28/23	0_42823UG			7,000						
PC 30/19	0_43019UG	6,680	7,267	8,100		15,100	25,000	2,800	8,000	7,000
PC 36/22	0_43622UG	8,700	9,467	10,200	10,800	17,500	32,667			9,000
PC 42/29	0_44229UG	9,200	10,000	12,000			40,000			9,000

HOW TO ORDER

OP 4 14 08 UG

- Shape code ←
- Ferrite core material ←
- Used for all ferrite types ←
- Approximate diameter in mm ←
- Approximate height (per set) in mm ←
- Geometry code ←

Pot cores are sold in sets.
Any practical gap available. See page 15.

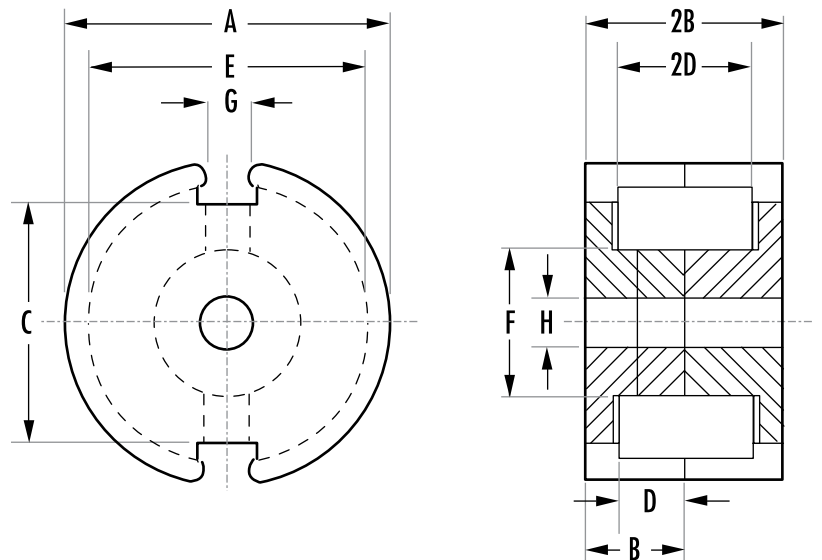

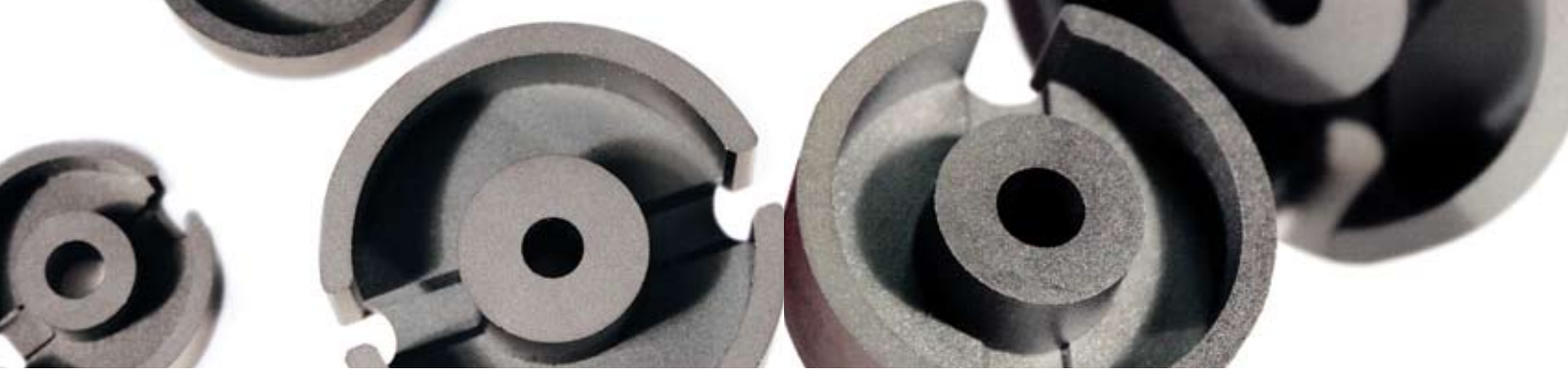

		MAGNETIC DATA						HARDWARE	
TYPE/SIZE	ORDERING CODE	I_e (mm)	A_e (mm ²)	A min (mm ²)	V_e (mm ³)	WaAc (cm ⁴)	Weight (grams per set)	Bobbins	Clips
PC 7/4	0_40704UG	9.9	7.0	5.9	69	0.002	0.5	✓	
PC 9/5	0_40905UG	12.5	10.1	8.0	126	0.003	0.8	✓	✓
PC 11/7	0_41107UG	15.5	16.2	13.2	251	0.006	1.8	✓	✓
PC 11/9	0_41109UG	16.2	16.3	13.2	264	0.01	1.9		
PC 14/8	0_41408UG	19.8	25.1	19.8	495	0.02	3.2	✓	✓
PC 18/11	0_41811UG	25.8	43.3	36.0	1,120	0.07	6.4	✓	✓
PC 18/14	0_41814UG	29.3	42.6	36.0	1,248	0.09	7.4		
PC 22/13	0_42213UG	31.5	63.4	50.9	2,000	0.18	13	✓	✓
PC 26/16	0_42616UG	37.6	93.9	77.4	3,530	0.39	20	✓	✓
PC 28/23	0_42823UG	48.1	128	101	6,160	0.58	32	✓	
PC 30/19	0_43019UG	45.2	137	116	6,190	0.74	34	✓	✓
PC 36/22	0_43622UG	53.2	202	172	10,700	1.53	57	✓	✓
PC 42/29	0_44229UG	68.6	265	214	18,200	3.68	104	✓	✓

Refer to page 58 for hardware information.

		DIMENSIONS (mm)									
TYPE/SIZE	ORDERING CODE	A	B	2B	C	D	2D	E	F	G	H
PC 7/4	0_40704UG	7.24 ± 0.15	2.08 ± 0.05	4.16 ± 0.1	4.72 nom	1.4 min	2.79 min	5.74 min	3.0 max	1.52 min	1.09 ± 0.05
PC 9/5	0_40905UG	9.3 + 0/-0.3	2.7 + 0/-0.15	5.4 + 0/-0.3	6.5 ± 0.25	1.8 + 0.15/-0	3.6 + 0.3/-0	7.5 + 0.25/-0	3.9 + 0/-0.2	2.0 ± 0.2	2.04 + 0.06/-0
PC 11/7	0_41107UG	11.1 ± 0.2	3.25 ± 0.05	6.5 ± 0.1	6.8 ± 0.25	2.2 + 0.15/-0	4.4 + 0.3/-0	9.0 + 0.4/-0	4.7 + 0/-0.2	2.2 ± 0.3	2.1 ± 0.1
PC 11/9	0_41109UG	11.28 + 0/-0.4	3.43 ± 0.08	6.86 ± 0.16	7.54 ± 0.2	2.48 ± 0.08	4.96 ± 0.16	9.0 + 0.4/-0	4.7 + 0/-0.2	1.8 + 0.3/-0	2.0 + 0.08/-0
PC 14/8	0_41408UG	14.3 + 0/-0.5	4.18 ± 0.06	8.35 ± 0.13	9.5 ± 0.3	2.8 + 0.2/-0	5.6 + 0.4/-0	11.6 + 0.4/-0	6.0 + 0/-0.2	2.7 + 1.2/-0	3.1 ± 0.1
PC 18/11	0_41811UG	18.0 ± 0.4	5.3 ± 0.05	10.6 ± 0.1	13.4 ± 0.3	3.7 ± 0.1	7.4 ± 0.2	15.15 ± 0.25	7.45 ± 0.15	3.8 ± 0.6	3.1 ± 0.1
PC 18/14	0_41814UG	18.0 ± 0.4	7.1 ± 0.2	14.2 ± 0.4	11.8 ± 0.25	5.05 + 0.2/-0	10.1 + 0.4/-0	14.0 + 0.4/-0	7.4 + 0/-0.3	3.6 + 0.3/-0	3.1 ± 0.08
PC 22/13	0_42213UG	22.0 + 0/-0.8	6.7 ± 0.1	13.4 ± 0.2	15.0 ± 0.4	4.6 + 0.2/-0	9.2 + 0.4/-0	17.9 + 0.6/-0	9.4 + 0/-0.3	3.8 ± 0.6	4.4 + 0.3/-0
PC 26/16	0_42616UG	25.5 ± 0.5	8.05 ± 0.1	16.1 ± 0.2	18.0 ± 0.4	5.5 min	11.0 min	21.6 ± 0.4	11.3 ± 0.2	3.8 ± 0.6	5.5 ± 0.1
PC 28/23	0_42823UG	27.7 ± 0.4	11.43 ± 0.15	22.86 ± 0.3	19.7 nom	8.15 min	16.3 min	22.0 min	12.88 max	3.81 min	5.56 ± 0.1
PC 30/19	0_43019UG	30.0 ± 0.5	9.45 ± 0.05	18.9 ± 0.1	20.5 ± 0.5	6.5 min	13.0 min	25.4 ± 0.4	13.3 ± 0.2	4.3 ± 0.6	5.5 ± 0.1
PC 36/22	0_43622UG	35.6 ± 0.6	10.95 ± 0.05	21.9 ± 0.1	26.2 ± 0.6	7.3 min	14.6 min	30.4 ± 0.5	15.9 ± 0.3	4.9 ± 0.6	5.55 ± 0.15
PC 42/29	0_44229UG	42.4 ± 0.7	14.7 ± 0.05	29.4 ± 0.1	32.0 ± 0.7	10.15 min	20.3 min	36.3 ± 0.7	17.4 ± 0.3	5.1 ± 0.6	5.55 ± 0.15

RS-DS Cores

Slab cores are modified pot cores with the sides removed. The slabs can be paired with one round half of a standard pot core (RS combination) or two slabs can be paired together for a double slab (DS combination).

The RS geometry offers all the advantages of pot cores for filter applications, plus many additional features for power applications. DS cores accommodate large size wire and assist in removing heat from the assembly.

Typical applications for RS-DS combinations include: low and medium power transformers, switched-mode power supplies, and converter and inverter transformers.

		NOMINAL A _L (MH/1000T)				
TYPE/SIZE	ORDERING CODE	R	P	F	J	W
DS 14/08	D_41408UG	1,653	1,800	2,474	3,260	7,929
HS 14/08	H_41408UG	1,533	1,667	1,990	4,107	7,043
RS 14/08	S_41408UG	1,760	1,913	2,274	4,500	7,643
DS 18/11	D_41811UG	3,038	3,236	3,697	5,174	7,386
HS 18/11	H_41811UG	2,666	2,827	3,197	5,140	5,899
RS 18/11	S_41811UG	2,942	3,112	3,498	5,760	6,194
DS 23/11	D_42311UG	3,440	3,747	4,460	8,400	16,064
HS 23/11	H_42311UG	3,200	3,460	4,170	7,853	14,021
RS 23/11	S_42311UG	3,687	4,013	5,200	7,875	16,071
DS 23/18	D_42318UG	2,907	3,160	3,800	6,347	10,000
HS 23/18	H_42318UG	2,600	2,820	3,350	5,333	10,000
RS 23/18	S_42318UG	3,066	3,333	4,000	6,400	12,000
DS 26/16	D_42616UG	3,827	4,160	5,000	8,093	13,000
HS 26/16	H_42616UG	3,630	3,840	4,600	8,107	13,000
RS 26/16	S_42616UG	4,360	4,733	5,300	8,933	15,714
DS 30/19	D_43019UG	4,440	4,827	5,800	9,493	15,000
HS 30/19	H_43019UG	4,227	4,600	5,525	9,507	15,000
RS 30/19	S_43019UG	5,533	6,027	6,700	11,147	18,571
DS 36/22	D_43622UG	5,400	5,827	6,360	9,000	19,000
HS 36/22	H_43622UG	5,200	5,400	6,050	8,550	18,100
RS 36/22	S_43622UG	7,120	7,580	8,660	13,400	26,500
DS 42/29	D_44229UG	6,500	7,000	7,900	12,200	
RS 42/29	S_44229UG	8,300	8,900	10,400	17,500	

HOW TO ORDER

S P 4 23 11 UG

- Shape code ← S
- Ferrite core material ← P
- Used for all ferrite types ← 4
- Approximate length in mm ← 23
- Approximate height (per set) in mm ← 11
- Geometry code ← UG

SHAPE CODE

- D - DS Core with solid centerpost
- H - DS Core with center hole
- S - RS core
- RS-DS cores are sold in sets.
- Any practical gap available, see page 15.
- For DS 42/29 size, see datasheets for drawings.

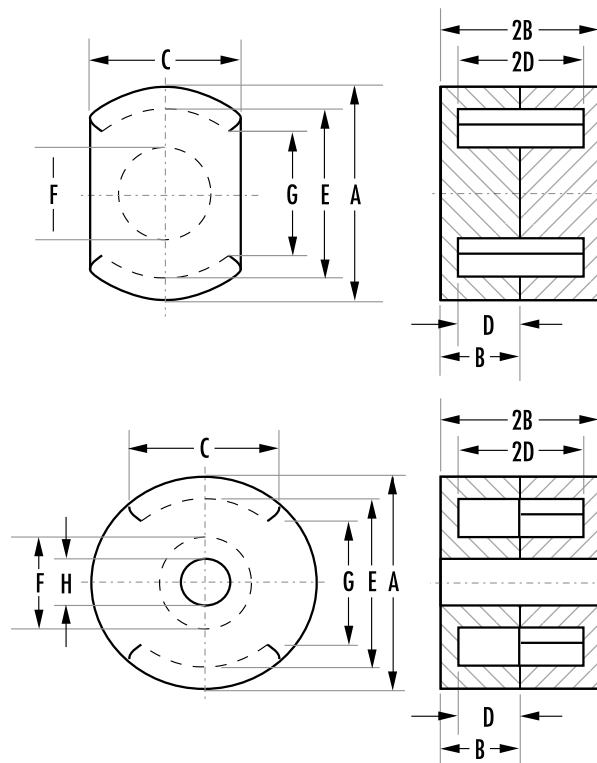

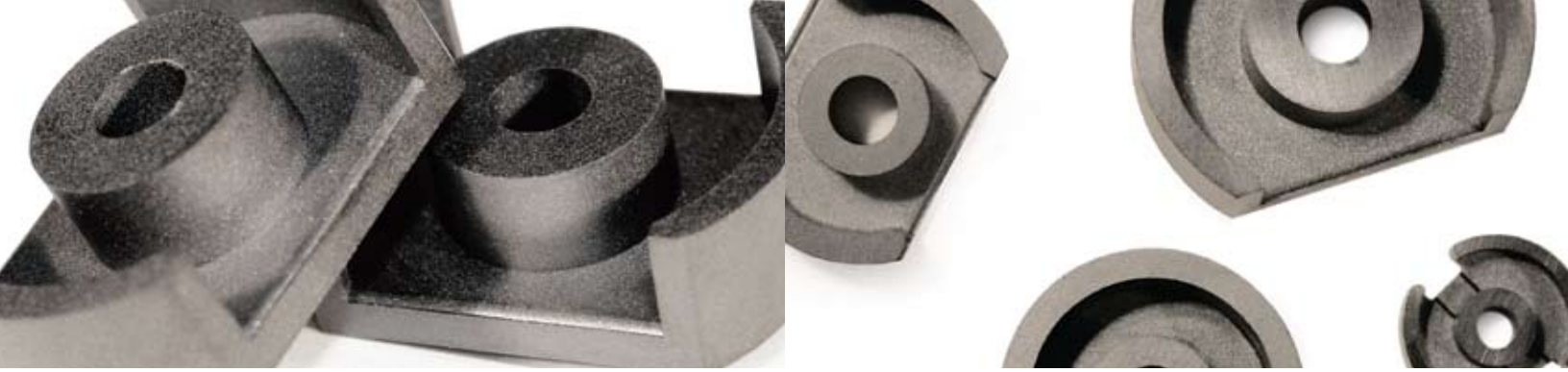

		MAGNETIC DATA						HARDWARE	
TYPE/SIZE	ORDERING CODE	I_e (mm)	A_e (mm ²)	A min (mm ²)	V_e (mm ³)	WaAc (cm ⁴)	Weight (grams per set)	Bobbins	Clips
DS 14/08	D_41408UG	22.6	24.6	23.5	556	0.02	3.4	✓	✓
HS 14/08	H_41408UG	20.6	21.0	19.2	433	0.02	2.6	✓	✓
RS 14/08	S_41408UG	20.2	23.0	19.2	460	0.02	2.8	✓	✓
DS 18/11	D_41811UG	29.1	40.0	36.3	1,167	0.07	7.1	✓	✓
HS 18/11	H_41811UG	28.7	37.2	31.0	1,070	0.05	6.6	✓	✓
RS 18/11	S_41811UG	27.2	40.6	32.9	1,110	0.07	6.8	✓	✓
DS 23/11	D_42311UG	26.8	51.2	37.8	1,370	0.08	10.0	✓	
HS 23/11	H_42311UG	27.0	48.2	37.8	1,300	0.08	9.1	✓	
RS 23/11	S_42311UG	28.6	61.0	53.6	1,740	0.10	10.5	✓	
DS 23/18	D_42318UG	39.9	58.0	40.7	2,310	0.21	13.0	✓	
HS 23/18	H_42318UG	40.1	53.4	40.7	2,130	0.20	12.1	✓	
RS 23/18	S_42318UG	41.6	62.2	53.6	2,590	0.22	14.0	✓	
DS 26/16	D_42616UG	38.9	77.0	62.7	3,000	0.32	15.0	✓	✓
HS 26/16	H_42616UG	39.0	72.1	62.7	2,810	0.30	14.4	✓	✓
RS 26/16	S_42616UG	38.3	82.6	62.7	3,180	0.35	15.5	✓	✓
DS 30/19	D_43019UG	49.5	120	111	5,940	0.63	31.0	✓	✓
HS 30/19	H_43019UG	46.1	111	96.0	5,110	0.60	26.0	✓	✓
RS 30/19	S_43019UG	45.6	123	96.0	5,610	0.67	30.5	✓	✓
DS 36/22	D_43622UG	56.9	162	140	9,250	1.22	47.6	✓	✓
HS 36/22	H_43622UG	57.6	157	140	9,030	1.19	46.3	✓	✓
RS 36/22	S_43622UG	55.4	179	140	9,944	1.36	51.0	✓	✓
DS 42/29	D_44229UG	76.0	232	211	17,600	3.22	90.5	✓	✓
RS 42/29	S_44229UG	72.3	244	211	17,641	3.35	90.6	✓	✓

Refer to page 58 for hardware information.

		DIMENSIONS (mm)									
TYPE/SIZE	ORDERING CODE	A	B	2B	C	D	2D	E	F	G	H
DS 14/08	D_41408UG	14.05 ± 0.25	4.15 ± 0.08	8.3 ± 0.15	9.4 ± 0.15	2.9 ± 0.1	5.8 ± 0.2	11.8 ± 0.2	5.9 ± 0.1	7.6 min	
HS 14/08	H_41408UG	14 ± 0.25	4.24 + 0/-0.13	8.48 + 0/-0.26	9.4 ± 0.15	2.8 min	5.58 min	11.6 min	5.99 max	7.6 min	3.1 ± 0.1
RS 14/08	S_41408UG	14 ± 0.25	4.24 + 0/-0.13	8.48 + 0/-0.26	9.4 ± 0.15	2.8 min	5.58 min	11.6 min	5.99 max	7.6 min	3.1 ± 0.1
DS 18/11	D_41811UG	18 ± 0.4	5.3	10.6 ± 0.15	11.9 ± 0.2	3.7	7.4 ± 0.2	15.15 ± 0.25	7.45 ± 0.15	11.2 min	
HS 18/11	H_41811UG	18 ± 0.4	5.3 ± 0.07	10.6 ± 0.15	11.9 ± 0.2	3.7 ± 0.1	7.4 ± 0.2	15.15 ± 0.25	7.45 ± 0.15	11.2 min	3.1 ± 0.1
RS 18/11	S_41811UG	18 ± 0.4	5.3 ± 0.07	10.6 ± 0.15	11.9 ± 0.2	3.7 ± 0.1	7.4 ± 0.2	15.15 ± 0.25	7.45 ± 0.15	11.2 min	3.1 ± 0.1
DS 23/11	D_42311UG	22.86 ± 0.46	5.54 ± 0.13	11.08 ± 0.26	15.24 ± 0.25	3.63 min	7.26 min	17.93 min	9.9 max	13.21 min	
HS 23/11	H_42311UG	22.86 ± 0.46	5.54 ± 0.13	11.08 ± 0.26	15.24 ± 0.25	3.63 min	7.26 min	17.93 min	9.9 max	13.21 min	5.1 ± 0.1
RS 23/11	S_42311UG	22.9 ± 0.45	5.5 ± 0.13	11 ± 0.25	15.2 ± 0.25	3.75 ± 0.13	7.5 ± 0.25	18.3 ± 0.35	9.7 ± 0.2	13.2 min	5.1 ± 0.1
DS 23/18	D_42318UG	22.86 ± 0.46	9 ± 0.18	18 ± 0.36	15.24 ± 0.25	6.93 min	13.86 min	17.93 min	9.9 max	13.21 min	
HS 23/18	H_42318UG	22.86 ± 0.46	9 ± 0.18	18 ± 0.36	15.24 ± 0.25	6.93 min	13.86 min	17.93 min	9.9 max	13.2 min	5.08 ± 0.1
RS 23/18	S_42318UG	22.9 ± 0.45	9 ± 0.18	18 ± 0.35	15.25 ± 0.25	7.2 ± 0.18	14.4 ± 0.35	18.3 ± 0.35	9.7 ± 0.2	13.2 min	5.1 ± 0.1
DS 26/16	D_42616UG	25.5 ± 0.51	8.05 ± 0.1	16.1 ± 0.2	17.09 nom	5.51 min	11.02 min	21.21 min	11.48 max	15.5 min	
HS 26/16	H_42616UG	25.5 ± 0.51	8.05 ± 0.1	16.1 ± 0.2	17.09 nom	5.51 min	11.02 min	21.21 min	11.48 max	15.5 min	5.56 ± 0.1
RS 26/16	S_42616UG	25.5 ± 0.51	8.05 ± 0.1	16.1 ± 0.2	17.09 nom	5.51 min	11.02 min	21.21 min	11.48 max	15.5 min	5.56 ± 0.1
DS 30/19	D_43019UG	30 ± 0.51	9.4 ± 0.1	18.8 ± 0.2	20.3 ± 0.25	6.5 min	13 min	25 min	13.51 max	15.49 min	
HS 30/19	H_43019UG	30 ± 0.51	9.4 ± 0.1	18.8 ± 0.2	20.32 ± 0.25	6.5 min	13 min	25 min	13.51 max	15.49 min	5.56 ± 0.1
RS 30/19	S_43019UG	30 ± 0.51	9.4 ± 0.1	18.8 ± 0.2	20.32 ± 0.25	6.5 min	13 min	25 min	13.51 max	15.49 min	
DS 36/22	D_43622UG	35.61 ± 0.51	10.85 ± 0.12	21.7 ± 0.25	23.85 nom	7.29 min	14.58 min	29.9 min	16.1 max	20.3 min	
HS 36/22	H_43622UG	35.61 ± 0.51	10.85 ± 0.12	21.7 ± 0.25	23.85 nom	7.29 min	14.58 min	29.85 min	16.1 max	20.3 min	5.56 ± 0.1
RS 36/22	S_43622UG	35.61 ± 0.51	10.9 ± 0.07	21.8 ± 0.15	23.85 nom	7.4 ± 0.1	14.8 ± 0.2	29.9 min	16.1 max	20.3 min	
DS 42/29	D_44229UG	42.4 ± 0.71	14.8 ± 0.2	29.6 ± 0.4	28.4 nom	10.21 min	20.42 min	35.61 min	17.7 max	25.0 min	
RS 42/29	S_44229UG	42.4 ± 0.71	14.8 ± 0.2	29.6 ± 0.4	28.4 nom	10.21 min	20.42 min	35.61 min	17.7 max	25.0 min	5.56 ± 0.1

PQ Cores

PQ cores are designed specifically for switched mode power supplies. This design provides an optimized ratio of volume to winding area and surface area. As a result, both maximum inductance and winding area are possible with a minimum core size. The cores provide maximum power output with minimum assembled transformer weight and volume, in addition to taking up a minimum amount of area on the printed circuit board.

Assembly with printed circuit bobbins and one piece clamps is simplified. This efficient design provides a more uniform cross-sectional area; thus cores tend to operate with fewer hot spots than with other designs.

Typical applications include power transformers and power inductors.

		NOMINAL A_L (MH/1000T)				
TYPE/SIZE	ORDERING CODE	L	R	P	F	T
PQ 20/16	0_42016UG	1,650	3,587	3,907	4,690	
PQ 20/20	0_42020UG	1,300	2,947	3,213	3,860	3,580
PQ 26/10	0_42610UG	3,900	7,733	8,413	8,080	
PQ 26/14	0_42614UG	2,700	5,613	6,113	7,335	
PQ 26/20	0_42620UG	2,640	5,560	6,053	7,270	7,020
PQ 26/25	0_42625UG	2,200	4,600	5,000	6,010	6,010
PQ 32/12	0_43214UG		6,867	7,467	8,960	
PQ 32/20	0_43220UG		6,640	7,213	8,875	7,560
PQ 32/30	0_43230UG		4,667	5,080	6,100	6,570
PQ 35/35	0_43535UG		4,813	5,240	7,347	6,000
PQ 40/40	0_44040UG		4,267	4,640	5,580	6,100
PQ 50/50	0_45050UG		7,400	8,195	9,639	9,500

HOW TO ORDER

OR 4 20 16 UG

- Shape code ←
- Ferrite core material ←
- Used for all ferrite types ←
- Approximate length in mm ←
- Approximate height (per set) in mm ←
- Geometry code ←

PQ cores are sold in sets.
For clip slot dimensions see individual data sheets.
Any practical gap is available. See page 15.

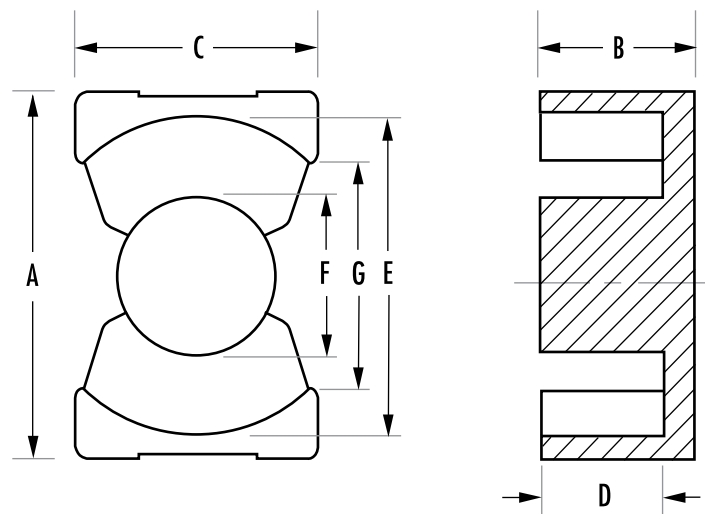

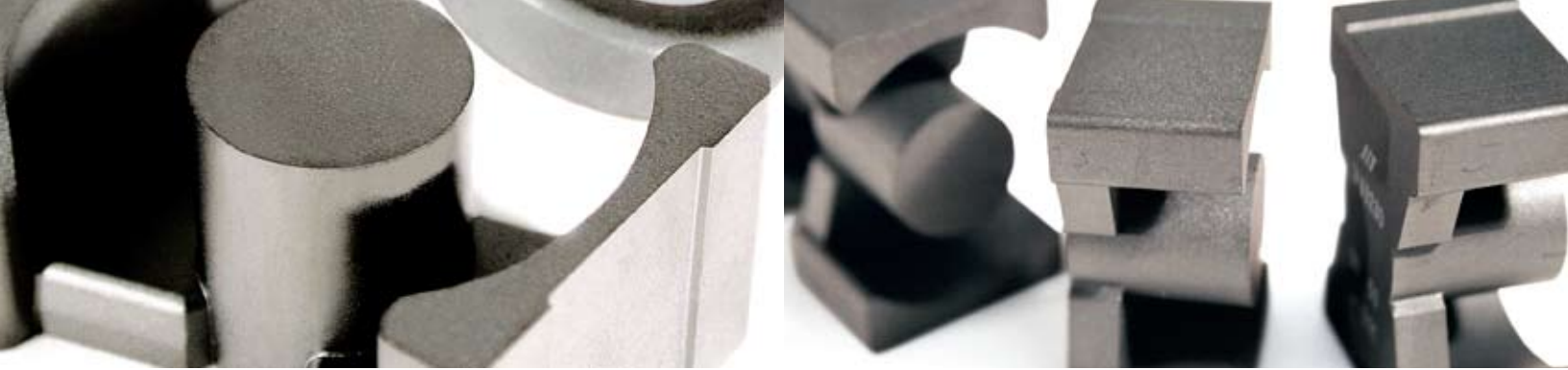

		MAGNETIC DATA						HARDWARE	
TYPE/SIZE	ORDERING CODE	l_e (mm)	A_e (mm ²)	A_{min} (mm ²)	V_e (mm ³)	W_{Ac} (cm ⁴)	Weight (grams per set)	Bobbins	Clips
PQ 20/16	0_42016UG	37.6	61.9	59.1	2,330	0.17	13	✓	✓
PQ 20/20	0_42020UG	45.7	62.6	59.1	2,850	0.23	16	✓	✓
PQ 26/10	0_42610UG	29.4	105	93.8	3,090	0.07	17		
PQ 26/14	0_42614UG	33.3	86.4	70.9	2,880	0.17	16		
PQ 26/20	0_42620UG	45.0	121	109	5,470	0.40	31	✓	✓
PQ 26/25	0_42625UG	54.3	120	108	6,530	0.60	36	✓	✓
PQ 32/12	0_43214UG	34.4	109	92.0	3,750	0.29	21		
PQ 32/20	0_43220UG	55.9	169	142	9,440	0.79	42	✓	✓
PQ 32/30	0_43230UG	74.7	167	142	12,500	1.66	57	✓	✓
PQ 35/35	0_43535UG	86.1	190	162	16,300	3.02	73	✓	✓
PQ 40/40	0_44040UG	102	201	175	20,500	4.84	97	✓	✓
PQ 50/50	0_45050UG	113	328	314	37,100	8.28	195	✓	

Refer to page 58 for hardware information.

		DIMENSIONS (mm)								
TYPE/SIZE	ORDERING CODE	A	B	2B	C	D	2D	E	F	G
PQ 20/16	0_42016UG	21.3 ± 0.4	8.1 ± 0.1	16.2 ± 0.2	14.0 ± 0.4	5.15 ± 0.15	10.3 ± 0.3	18.0 ± 0.4	8.8 ± 0.2	12.0 min
PQ 20/20	0_42020UG	21.3 ± 0.4	10.1 ± 0.1	20.2 ± 0.2	14.0 ± 0.4	7.15 ± 0.15	14.3 ± 0.3	18.0 ± 0.4	8.8 ± 0.2	12.0 min
PQ 26/10	0_42610UG	27.2 ± 0.45	5.1 ± 0.1	10.2 ± 0.2	19.0 ± 0.45	1.2 min	2.39 min	22.05 min	12.2 max	15.5 min
PQ 26/14	0_42614UG	27.2 ± 0.45	5.94 ± 0.1	11.9 ± 0.2	19.0 ± 0.45	3.4 min	6.7 min	22.05 min	12.2 max	15.5 min
PQ 26/20	0_42620UG	27.3 ± 0.46	10.1 ± 0.13	20.2 ± 0.25	19.0 ± 0.45	5.75 ± 0.15	11.5 ± 0.3	22.5 ± 0.45	12.0 ± 0.2	15.5 min
PQ 26/25	0_42625UG	27.3 ± 0.46	12.35 ± 0.13	24.7 ± 0.25	19.0 ± 0.45	8.05 ± 0.15	16.1 ± 0.3	22.5 ± 0.46	12.0 ± 0.2	15.5 min
PQ 32/12	0_43214UG	33.0 ± 0.5	5.94 ± 0.1	11.9 ± 0.2	22.0 ± 0.5	3.4 min	6.7 min	27.0 min	13.75 max	19.0 min
PQ 32/20	0_43220UG	33.0 ± 0.5	10.3 ± 0.13	20.6 ± 0.25	22.0 ± 0.5	5.75 ± 0.15	11.5 ± 0.3	27.5 ± 0.5	13.5 ± 0.25	19.0 min
PQ 32/30	0_43230UG	33.0 ± 0.5	15.15 ± 0.13	30.3 ± 0.25	22.0 ± 0.5	10.65 ± 0.15	21.3 ± 0.3	27.5 ± 0.5	13.5 ± 0.25	19.0 min
PQ 35/35	0_43535UG	36.1 ± 0.6	17.35 ± 0.13	34.7 ± 0.25	26.0 ± 0.5	12.5 ± 0.15	25.0 ± 0.3	32.0 ± 0.5	14.4 ± 0.25	23.5 min
PQ 40/40	0_44040UG	41.5 ± 0.9	19.9 ± 0.15	39.8 ± 0.3	28.0 ± 0.6	14.75 ± 0.2	29.5 ± 0.4	37.0 ± 0.6	14.9 ± 0.3	29.0 ± 1.0
PQ 50/50	0_45050UG	51.0 ± 0.7	25.0 ± 0.25	50.0 ± 0.5	32.0 ± 0.6	18.05 ± 0.3	36.1 ± 0.6	44.0 ± 0.7	20.0 ± 0.35	32.0 min

RM Cores

RM cores are square-designed cores that offer all the magnetic and mechanical advantages of pot cores, plus the added feature of maximizing magnetic performance while minimizing PC board space.

Easy to assemble and adaptable to automation, completed units provide at least 40% savings in mounting area compared to a similar size pot core assembly.

Typical applications include differential mode inductors, power inductors, filter inductors, telecom inductors and broadband transformers.

TYPE/SIZE	ORDERING CODE	NOMINAL A_L (MH/1000T)								
		L	R	P	F	T	J	W	C	V
RM 4 N	N_41110UG	560	1,125	1,191	1,333		1,752	3,518		
RM 4	R_41110UG		920	1,000	1,200		1,973	3,000		
RM 5 N	N_41510UG	900	1,720	1,867	2,100		4,133	6,000		
RM 5	R_41510UG		1,720	1,867	2,100		4,133	6,000	800	1,960
RM 6R N	N_41812UG	1,230	2,387	2,600	3,080		6,707	8,600		
RM 6R	R_41812UG		2,187	2,333	2,800		5,973	7,714		2,700
RM 6S N	N_41912UG	1,250	2,213	2,400	2,880		6,000	8,600		
RM 6S	R_41912UG		1,987	2,160	2,600		5,387	7,714		
RM 7 N	N_42013UG	1,450	3,058	3,244	3,675		5,001	9,571		
RM 8 N	N_42316UG	1,700	2,700	2,933	5,210		8,000	12,200		
RM 8	R_42316UG		2,347	2,560	3,500		6,960	10,600		
RM 10 N	N_42819UG	2,200	4,047	4,400	5,500	5,500	9,987	16,000		
RM 10	R_42819UG				4,750					
RM 12 N	N_43723UG		4,600	5,000	6,000	6,790	11,800	22,600		
RM 14 N	N_44230UG		7,000	7,540	8,782	8,130	13,096	20,735		

HOW TO ORDER

R P 4 15 10 UG

Shape code ←
 Ferrite core material ←
 Used for all ferrite types ←
 Approximate diameter in mm ←
 Approximate height (per set) in mm ←
 Geometry code ←

SHAPE CODE

N — RM core with solid centerpost
 R — RM core with center hole

RM cores are sold in sets.
 Any practical gap available. See page 15.

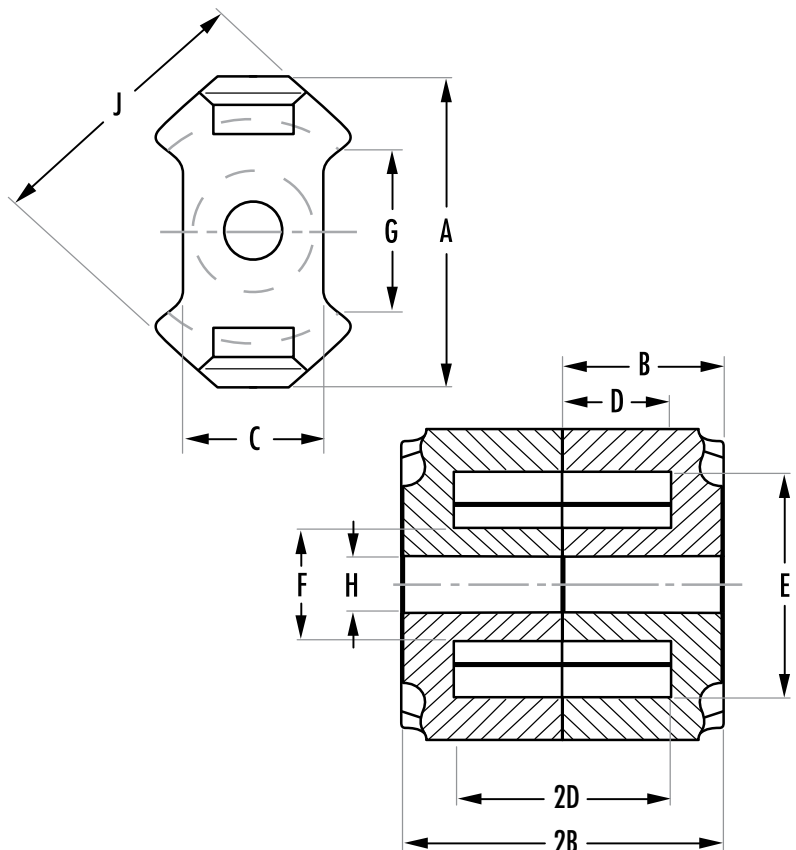

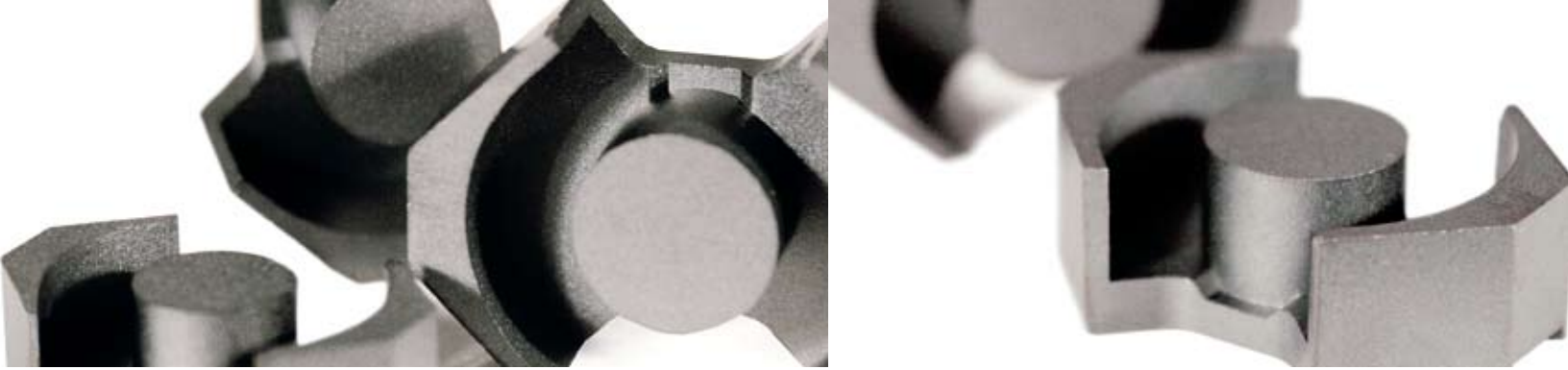

TYPE/SIZE	ORDERING CODE	MAGNETIC DATA						HARDWARE	
		l_e (mm)	A_e (mm ²)	A min (mm ²)	V_e (mm ³)	WaAc (cm ⁴)	Weight (grams per set)	Bobbins	Clips
RM 4 N	N_41110UG	23.3	13.8	11.5	322	0.01	1.7	✓	✓
RM 4	R_41110UG	20.6	10.8	7.9	222	0.01	1.5	✓	✓
RM 5 N	N_41510UG	23.2	24.8	18.1	574	0.02	3.2	✓	✓
RM 5	R_41510UG	21.4	21.0	13.9	449	0.02	3.1	✓	✓
RM 6R N	N_41812UG	27.5	38.0	31.2	1,040	0.06	5.4	✓	✓
RM 6R	R_41812UG	25.6	32.0	22.6	819	0.05	4.5	✓	✓
RM 6S N	N_41912UG	29.2	37.0	31.2	1,090	0.06	5.5	✓	✓
RM 6S	R_41912UG	27.0	31.0	22.6	837	0.05	5.1	✓	✓
RM 7 N	N_42013UG	30.0	44.1	39.6	1,325	0.17	7.5		
RM 8 N	N_42316UG	38.4	63.0	55.4	2,440	0.19	13	✓	✓
RM 8	R_42316UG	35.5	52.0	36.9	1,850	0.16	11	✓	✓
RM 10 N	N_42819UG	44.6	96.6	89.1	4,310	0.44	22	✓	✓
RM 10	R_42819UG	41.7	83.2	65.3	3,470	0.41	18	✓	✓
RM 12 N	N_43723UG	56.6	146	125	8,340	1.07	46	✓	
RM 14 N	N_44230UG	70.0	198	168	13,900	1.73	69		

Refer to page 58 for hardware information.

TYPE/SIZE	ORDERING CODE	DIMENSIONS (mm)										
		A	B	2B	C	D	2D	E	F	G	H	J
RM 4 N	N_41110UG	11.0+0/-0.5	5.2±0.05	10.4±0.1	4.6+0/-0.2	3.5+0.2/-0	7.0+0.4/-0	7.95+0.4/-0	3.9+0/-0.2	5.8 min		9.8+0/-0.4
RM 4	R_41110UG	11.8 max	5.2±0.05	10.4±0.1	4.45 nom	3.61±0.1	7.21±0.2	8.15±0.2	3.8±0.1	5.79 ref	2.05±0.05	9.6±0.2
RM 5 N	N_41510UG	14.6+0/-0.6	5.2±0.05	10.4±0.1	6.8+0/-0.4	3.25±0.1	6.5±0.2	10.2+0.4/-0	4.9+0/-0.2	6.0 min		12.3+0/-0.5
RM 5	R_41510UG	14.9 max	5.2±0.05	10.4±0.1	6.6 nom	3.25±0.1	6.5±0.2	10.4±0.2	4.8±0.1	6.71 nom	2.05±0.05	12.05±0.25
RM 6R N	N_41812UG	17.9+0/-0.7	6.2±0.05	12.4±0.1	7.4+0/-0.4	4.0+0.2/-0	8.0+0.4/-0	12.4+0.5/-0	6.4+0/-0.2	5.85 nom		14.7+0/-0.6
RM 6R	R_41812UG	18.3 max	6.2±0.05	12.4±0.1	7.4 nom	4.1±0.1	8.2±0.2	12.65±0.25	6.25±0.15	5.85 nom	3.05±0.05	14.4±0.3
RM 6S N	N_41912UG	18.3 max	6.2±0.05	12.4±0.1	8.2 nom	4.1±0.1	8.2±0.2	12.65±0.25	6.25±0.15	9.0 nom		14.4±0.3
RM 6S	R_41912UG	18.3 max	6.2±0.05	12.4±0.1	8.2 nom	4.1±0.1	8.2±0.2	12.65±0.25	6.25±0.15	9.0 nom	3.05±0.05	14.4±0.3
RM 7 N	N_42013UG	20.3+0/-0.8	6.7±0.05	13.4±0.1	7.25+0/-0.3	4.2+0.25/-0	8.4+0.5/-0	14.75+0.6/-0	7.25+0/-0.3	9.3 min		17.2+0/-0.7
RM 8 N	N_42316UG	23.2+0/-0.9	8.2±0.05	16.4±0.1	11.0+0/-0.5	5.5±0.1	11.0±0.2	17.0+0.6/-0	8.55+0/-0.3	9.5 min		19.7+0/-0.8
RM 8	R_42316UG	23.2 max	8.2±0.05	16.4±0.1	10.8 nom	5.53±0.13	11.05±0.25	17.5±0.35	8.4±0.15	11.7 nom	4.5±0.1	19.3±0.4
RM 10 N	N_42819UG	28.5+0/-1.3	9.3±0.05	18.6±0.1	13.5+0/-0.5	6.2+0.3/-0	12.4+0.6/-0	21.2+0.9/-0	10.9+0/-0.4	10.9 min		24.7+0/-1.1
RM 10	R_42819UG	28.5+0/-1.3	9.3±0.05	18.6±0.1	13.5+0/-0.5	6.2+0.3/-0	12.4+0.6/-0	21.2+0.9/-0	10.9+0/-0.4	10.9 min	5.4+0.2/-0	24.7+0/-1.1
RM 12 N	N_43723UG	37.4+0/-1.3	12.25±0.05	24.5±0.1	16.1+0/-0.5	8.4+0.3/-0	16.8+0.6/-0	24.9+1.1/-0	12.8+0/-0.4	12.9 min		29.8+0/-1.1
RM 14 N	N_44230UG	42.2+0/-1.4	15.05±0.05	30.1±0.1	19.0+0/-0.6	10.4+0.3/-0	20.8+0.6/-0	29.0+1.2/-0	15.0+0/-0.6	17.0 nom		34.8+0/-1.3

Hardware



SIZE	TYPE	P/N	SIZE	TYPE	P/N	SIZE	TYPE	P/N	SIZE	TYPE	P/N	SIZE	TYPE	P/N	SIZE	TYPE	P/N						
0200	TC	SMC06018A	1408	PC	O0B140801	1912	RM	O0C181211	2507	TC	TVB2908TA	3113	TC	TVB2908TA	4119	EC	PCH411901						
		SMH05025A			RS/DS			O0B140802			PCB181241			TVH22064A			TVB3610FA	4216	EER	PCB4216FA			
		SMH07058A			O0C140811			PCB181261			TVH25074A			TVB3610FA			4229	PC	O0B422901				
0301	TC	SMC06018A			O0W140815			TBA181201	2508	TC	TVB2908TA			TVH38134A			O0B422902						
		SMH05025A			PCB140811			TCA1812C2			TVH22064A	3220	PQ	O0C322017			O0C422917	PCB4229L1					
		SMH07058A			PCB140812	2016	PQ	O0C201612			TVH25074A	3230	PQ	O0C323017			TBP69000	TCF2800B1					
0401	TC	SMC06018A			PCB140821			PCB2016FB	2510	EC	O0B251001	3230	PQ	O0C323017			TCF2800B1						
		SMH05025A			PCB140822	2019	EFD	O0C2019B1			PCB2510V1			3434	ETD	PCB343416			TCF4000B1				
		SMH07058A			PCB140861			PCB2019B1			PCB2510V2					O0C3434FB	4317	EC	PCB4317M1				
0402	TC	SMC06018A			PCB1408S1			O0C202012	2515	EC-EC	O0B251501	3515	EC	O0B351501	4416	TC	TVH49164A						
		SMH05025A			SMH1408TA	2020	PQ	PCB2020FB			O0C2520TA			2520			EC	O0C2520TA	4444	ETD	O0C444416	PCB444418	
		SMH07058A			TBA140800	2106	TC	TVB22066A			O0C2523B1			2616			PC	O0B261601	3517	EC	O0B351701	4715	TC
SMH05025A	1434	P-EC	O0C143420			TVH22064A	PCB2523B1	O0B261602	O0C351717	4721	EC	PCB4721M1											
SMH07058A	1450	TC	TVB22066A	2109	TC	TVB22066A	TVH25074A	O0B261603	OCC351700	4916	TC	TVH49164A											
0502	TC	SMC06018A			TVH22064A			TVB2908TA	2523	EFD	O0C261614	3521	EER	PCB3521LA	4920	TC	TVH49164A						
		SMH05025A	1506	TC	TVB22066A			TVH22064A			PCB261611			O0C261614			PCB351701	4925	TC	TVH49164A			
		SMH07058A			TVH22064A	2120	EP	OAC212016			PCB261612			PCB261613			PCB3515M1	4932	TC	TVH49164A			
0601	TC	SMC06018A			O0C111012			OBC212016	2620	PQ	O0C262012	3535	PQ	O0C353517	4949	ETD	O0C494916						
		SMH05025A	1510	RM	O0C111012			PCB2120TB			PCB261621			PCB261622			PCB3535LA			PCB494920	PCB4949WA		
		SMH07058A			PCB15104A	2206	TC	TVB22066A			PCB261621			PCB261622			TVH38134A	3610	TC	TVB3610FA	5050	PQ	O0B5050B1
0603	TC	SMC06018A			PCB15104B			TVB2908TA	2625	PQ	O0C262512	3615	TC	TVB3610FA	5224	EC	OAC522423						
		SMH07058A			PCB151061			TVH22064A			PCB261622			PCB2616TA			TVH38134A	3622	PC	O0B362201			OBC522400
		SMH07058A			PCB151081	2207	TC	TVB22066A			TBP669000			TCF2800B1			RS/DS	O0C362202			O0C362200		
0704	PC	O0B070401			O0C1515TA			TVB2908TA	2819	RM	O0C281916	3622	RS/DS	O0C362217	5454	ETD	O0C5454B1						
		SMB07076B	1515	EFD	O0C1515TA			TVH22064A			PCB2620LA			O0C262512			PCB2625LA			O0C362211			O0B5224B1
		SMB07076A			O0C1515B1			TVH25074A			PCB2620LA			PCB262512			PCB2625LA			PCB3622L1			PCB5454B1
0905	PC	O0B090501			PCB1515B1			TVB2908TA	2823	PC	O0C282301	3806	TC	TVB3610FA	5528	EC	O0B5528B1						
		O0C090511	1605	TC	TVB22066A			TVH22064A			PCB2819L1			O0C262512			PCB2625LA			TCF2800B1			PCB5528WC
		O0C090511			TVH22064A	2212	TC	TVB22066A			TVH22064A			PCB2819L1			PCB262512			TCF2800B1			PCB5528WC
0906	ER	O0C09061A			O0C17172A			TVB2908TA	2908	TC	TVB2908TA	3813	TC	TVB3610FA	5530	EC	PCB5530FA						
		SMB09068A	1717	EP	O0C17172A			TVH22064A			TVB2908TA			TVB3610FA			TVH38134A			O0B572401			PCB5724M1
		SMB09068A			PCB17178A			TVH25074A			TVH22064A			TVB3610FA			TVH38134A			PCB5724M1			PCB5724M1
1009	EFD	O0C1009B1			O0C180520			TVH25074A	2915	TC	TVB2908TA	3825	TC	TVB3610FA	5810	EC-IC	O0C581001						
		PCB1009B1	1805	P-EC	O0C180520			TVH25074A			TVB2908TA			TVB3610FA			TVH38134A			O0C581002			O0C595916
		PCB10108A	1808	EC	O0B180801			O0B221301			TVB3610FA			TVH38134A			TVH49164A			O0C595916			PCB5959A
1010	EP	O0C10102A			PCB1808B1			O0B221302	2929	ETD	O0C2929B1	3825	TC	TVB3610FA	6113	TC	TVH49164A						
		SMB10108A	1809	TC	TVB22066A			O0B221303			TVH25074A			PCB2929B1			TVH38134A			TVH49164A			TVH61134A
		SMB10108A			TVH22064A	2213	PC	O0B221301			O0W221324			PCB3007T1			TVH49164A			TVH49164A			TVH61134A
1107	PC	O0B110701			O0C221314			O0B221302	3007	EC	PCB3007T1	3939	ETD	O0C393916	6326	TC	TVH49164A						
		O0B1107A2			O0C221314			O0B221303			O0C221314			O0C393916			PCB3939SB			PCB5939SB			PCB703501
		O0C110711	1811	PC	O0B181101			O0B221303			OPC221314			O0B301901			O0C393916			PCB703501			PCB703501
1110	RM	SMH11078A			O0B181102			O0B221303	3009	EC	PCB3009LA	4015	TC	TVH49164A	6410	EC-IC	O0C641001						
		SMH11078A			O0B181103			O0B221303			PCB221312			O0B301901			O0C393916			O0C641002			O0B652701
		SMH11078A			O0B181103			O0B221303			PCB221321			O0B301902			O0C393916			O0C641002			O0B703501
1212	EFD	O0C1212B1			O0B181103			O0B221303	3019	PC	O0B301901	4020	EC-IC	O0B402021	7035	EC	O0B703501						
		PCB1212B1			O0B181103			O0B221303			PCB221322			O0B301902			O0C404017			O0C703531			O0C703531
		PCB1212B1			O0B181103			O0B221303			PCB221322			O0B301903			PCB4040FA			O0C703531			O0C703531
1313	EP	OAC131316			PCB181112			O0B221303	3030	EFD	O0C3030B1	4119	EC	O0B411901	7228	EC	O0B722801						
		OBC131314			PCB181122			O0B221303			PCB231651			O0C3030B1			O0B411919			O0B722801			O0B802001
		PCB1313B1			SMH1811LA			O0B221303			PCB231652			O0C3030B1			O0C411900			O0B802001			O0B802001
1406	TC	SMB1313B1			TCA1811B1			O0C221314	2216	P-EC	O0C221620	4202	EC	PCB4022N1	7035	EC	O0B703501						
		TVB22066A	1812	RM	O0C181211			O0C221314			PCB301921			PCB301921			O0C404017			O0C703531			O0C703531
		TVH22064A			TCA181211			O0C221314			PCB301921			PCB301921			PCB4040FA			O0C703531			O0C703531
1407	TC	TVB22066A			PCB181241			O0C221314	2316	RM	O0C231615	4202	PQ	O0C404017	7035	EC	O0B703501						
		TVH22064A			PCB181241			O0C221314			TBP669000			PCB301921			PCB4040FA			O0C703531			O0C703531
		TVH22064A			PCB181241			O0C221314			TBP669000			PCB301921			PCB4040FA			O0C703531			O0C703531
1407	TC	TVB22066A			PCB181261			O0C221314	2316	RM	O0C231615	4202	PQ	O0C404017	7035	EC	O0B703501						
		TVH22064A			PCB181261			O0C221314			TBP669000			PCB301921			PCB4040FA			O0C703531			O0C703531
		TVH22064A			TBA181201			O0C221314			TBP669000			PCB301921			PCB4040FA			O0C703531			O0C703531
1407	TC	TVH22064A			TCA1812C2			O0C221314	2318	RS/DS	PCB2318T1	4202	PQ	O0C404017	7035	EC	O0B703501						
		TVH22064A			TCA1812C2			O0C221314			TBP669000			PCB301921			PCB4040FA			O0C703531			O0C703531
		TVH22064A			TCA1812C2			O0C221314			TBP669000			PCB301921			PCB4040FA			O0C703531			O0C703531

Power Design

Ferrite is an ideal core material for transformers, inverters and inductors in the frequency range 20 kHz to 3 MHz, due to the combination of low core cost and low core losses. Ferrites may be used in the saturating mode for low power, low frequency operation (<50 watts and 10 kHz). Ferrite cores may also be used in fly-back transformer designs, which offer low core cost, low circuit cost and high voltage capability. Powder cores (MPP, High Flux, Kool Mu[®] XFLUX[®], and AmoFlux[®]) offer soft saturation, higher B max and better temperature stability and may be the best choice in some flyback or inductor applications.

CORE GEOMETRIES

POT CORES

Pot Cores, when assembled, nearly surround the wound bobbin. This aids in shielding the coil from pickup of EMI from outside sources. The pot core dimensions follow IEC standards so that there is interchangeability between manufacturers. Both plain and printed circuit bobbins are available, as are mounting and assembly hardware.

ROUND SLAB, DOUBLE SLAB & RM CORES

Slab-sided solid center post cores resemble pot cores, but have a section cut off on either side of the skirt. The additional openings allow larger wires to be accommodated and assist in removing heat from the assembly. RM cores are also similar to pot cores, but are designed to minimize board space, providing at least a 40% savings in mounting area. Printed circuit or plain bobbins are available. One piece clamps permit simple assembly. Low profile is possible. The solid center post generates less core loss and minimizes heat buildup.

PQ CORES

PQ cores are designed specifically for switched mode power supplies. The design optimizes the ratio of core volume to winding and surface area. As a result, power output, inductance and winding area are maximized with a minimal core weight, volume and PCB footprint. Assembly is simple using printed circuit bobbins and one piece clamps. This efficient design provides a more uniform cross-sectional area; cores tend to operate with fewer hot spots than with other geometries.

EC, ETD AND EER CORES

These shapes combine the benefits of E cores and pot cores. Like E cores, they have a wide opening on each side. This provides ample space for the large wires used for low output voltage switched mode power supplies. It also increases the flow of air which keeps the assembly cooler. The center post is round, like that of the pot core. One of the advantages of the round center post is that the winding has a shorter path length around it (11% shorter) than the wire around a square center post with an equal area. This reduces the losses of the windings by 11% and enables the core to handle a higher output power. The round center post eliminates the sharp bend in the wire that occurs with winding on a square center post.

E, ER AND PLANAR E CORES

E cores offer the advantage of simple bobbin winding and ease of assembly. A wide variety of standard lamination-size, metric and DIN sizes are available. E cores are a low-cost choice in designs that do not require self-shielding. Planar cores are the best selection for low profile applications. Copper traces that are layered in the printed circuit board are the windings in most planar applications. This type of design provides superior thermal characteristics, economical assembly, low leakage inductance, and excellence in consistency of performance.

EP CORES

EP Cores are round center-post cubical shapes which enclose the coil completely except for the printed circuit board terminals. The particular shape minimizes the effect of air gaps formed at mating surfaces in the magnetic path and provides a larger volume ratio to total space used. Shielding is excellent.

TOROIDS

Toroids are the least expensive ferrite shape. Available in a variety of sizes, outer diameters of 2.54 mm – 140 mm, toroids have good self-shielding properties. The fact that the core is a solid with no sections to assemble makes it a good choice if mechanical integrity is important in a high vibration environment. Toroid cores are available uncoated or with an epoxy, nylon or Parylene coating.

CORE MATERIALS

POWER

Magnetics R, P, F, T and L materials provide superior saturation, high temperature performance, low losses and product consistency.

T material is ideal for consistent performance over a wide temperature range. Applications for T include: Automotive, Electronic Lighting, Outdoor LCD Screens, Mobile Hand-held Devices and AC adapters and chargers.

L material was formulated for high-frequency and high-temperature applications. L is designed for DC-DC converters, Filters and Power Supplies that operate from 0.5 – 3 Megahertz. Curie temperature is high for a ferrite material at 300°C.

R material provides the best core losses for frequencies up to 500 kHz.

P material offers similar properties to R material, but is more readily available in some sizes.

F material is an established material with a relatively high permeability and 210°C Curie temperature.

Power Supplies, DC-DC Converters, Handheld Devices, High Power Control (gate drive) and EMI Filters are just a few of the applications that are typical for Magnetics ferrite power materials.

FILTER

Magnetics high permeability materials are engineered for optimum frequency and impedance performance in signal, choke and filter applications.

J and W materials offer high impedance for broad band transformers, and are also suitable for low-level power transformers.

J material is a medium perm general-purpose material.

J's properties are well suited both for EMI/RFI filtering and broadband transformers.

W material has set the industry standard for high perm materials. In filter applications, W perm has 20-50% more impedance below 1 MHz than J perm.

LINEAR FILTERS AND SENSORS

Magnetics C, E and V materials offer excellent properties for low-level signal applications. These materials set the standard for high quality factor, long-term stability and precise and adjustable inductance. Applications for these materials include high Q filters, wideband transformers, pulse transformers and RLC tuned circuits.

Inductor Design

Ferrite E cores and pot cores offer the advantages of decreased cost and low core losses at high frequencies. For switching regulators, power materials are recommended because of their temperature and DC bias characteristics. By adding air gaps to these ferrite shapes, the cores can be used efficiently while avoiding saturation.

These core selection procedures simplify the design of inductors for switching regulator applications. One can determine the smallest core size, assuming a winding factor of 50% and wire current carrying capacity of 500 circular mils per ampere.

Only two parameters of the design applications must be known:

- (a) Inductance required with DC bias
- (b) DC current

1. Compute the product of LI^2 where:

- L = inductance required with DC bias (millihenries)
- I = maximum DC output current + 1/2 AC Ripple

2. Locate the LI^2 value on the Ferrite Core Selector charts on the following page.

Follow this coordinate in the intersection with the first core size curve. Read the maximum nominal inductance, A_L , on the Y-axis. This represents the smallest core size and maximum A_L at which saturation will be avoided.

3. Any core size line that intersects the LI^2 coordinate represents a workable core for the inductor if the core's A_L value is less than the maximum value obtained on the chart.

4. Required inductance L, core size, and core nominal inductance (A_L) are known. Calculate the number of turns using

$$N = 10^3 \sqrt{\frac{L}{A_L}}$$

where L is in millihenries.

5. Example: If $I_{MAX} = 8$ Amps; L, inductance required = 100 μ Henries
 $LI^2 = (0.100 \text{ mH}) \times (8^2 \text{ Amps}) = 6.4$ millijoules

6. There are many ferrite cores available that will support the energy required. Any core size that the LI^2 coordinate intersects can be used at the A_L value shown on the chart.

7. Some choices based upon an LI^2 value of 6.4 millijoules are:

- Pot core 43622 $A_L = 400$ Double Slab 43622 $A_L = 250$
- PQ core 43220 $A_L = 300$ E core 44317 $A_L = 250$

8. For the following A_L values the number of turns required is:

- $A_L = 400, N = 16$ $A_L = 300, N = 19$ $A_L = 250, N = 20$

Make sure the wire size chosen will support the current and fit into the core set.

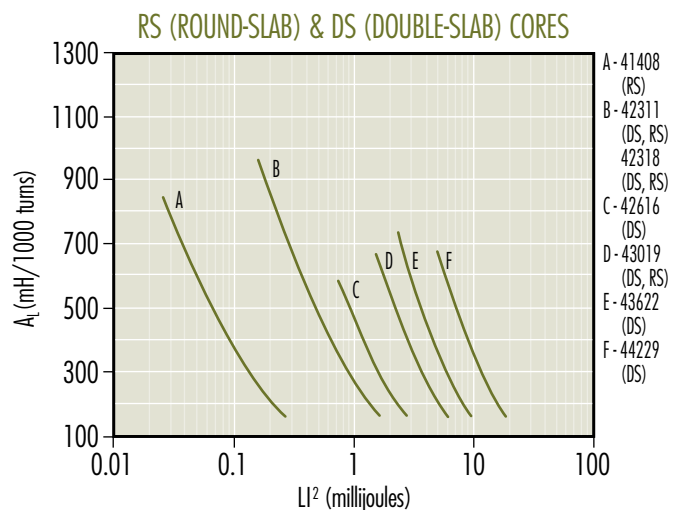
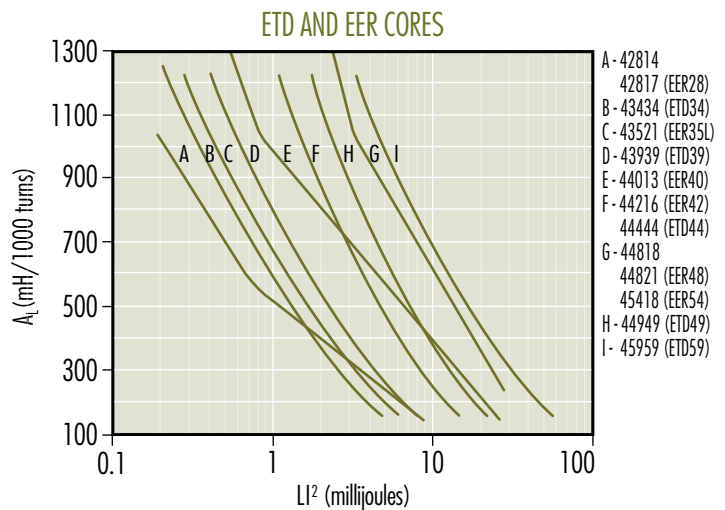
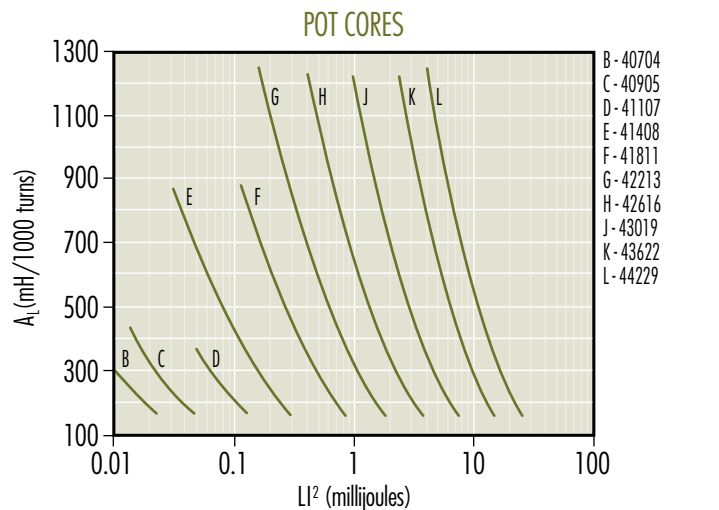

Inductor Design

RM AND EP CORES

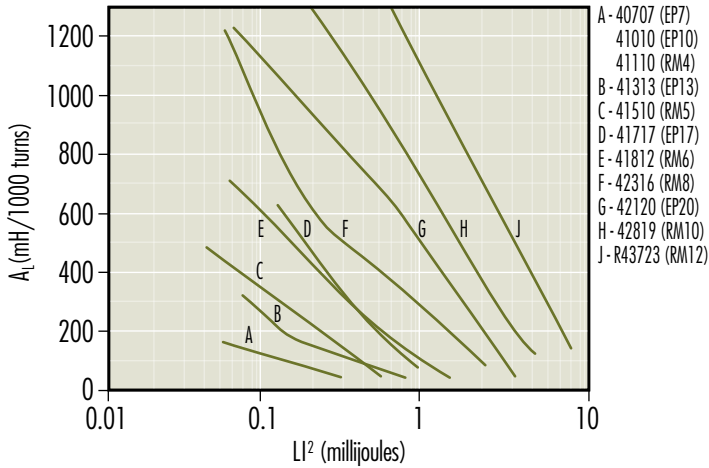

PQ CORES

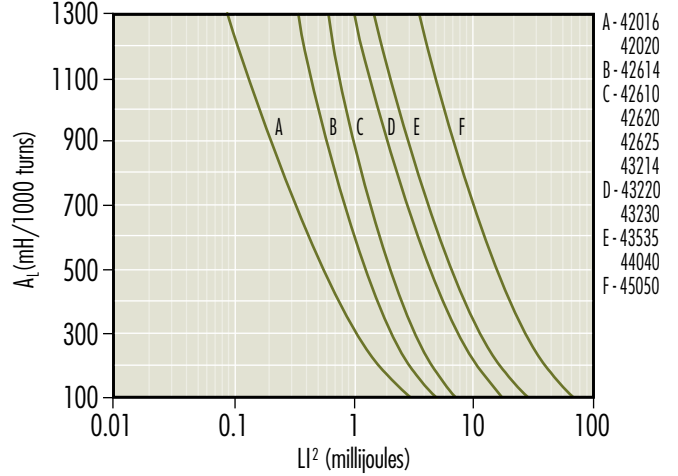

LAMINATION SIZE E CORES

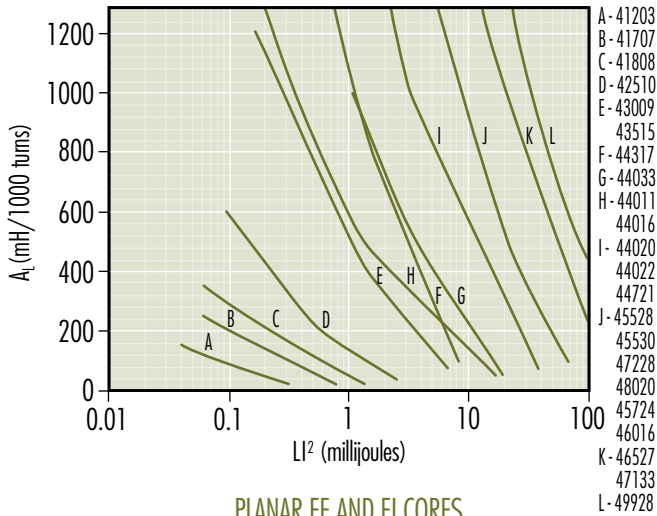

E CORES

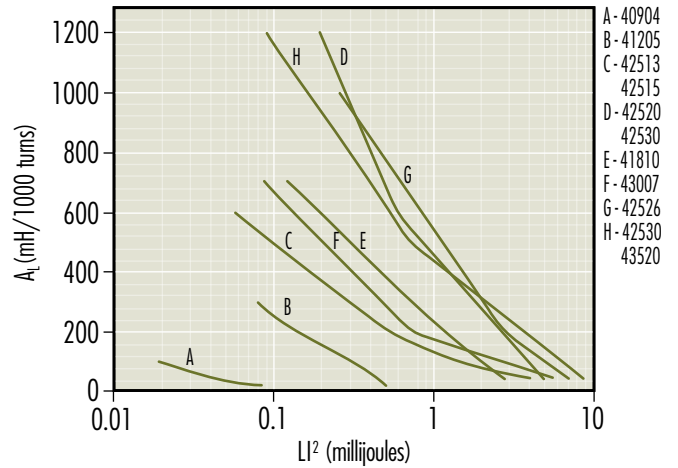

PLANAR EE AND EI CORES

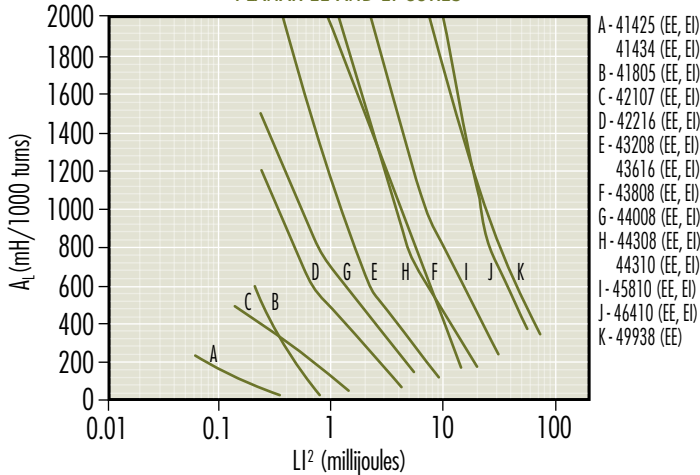

ER, EFD, AND EC CORES

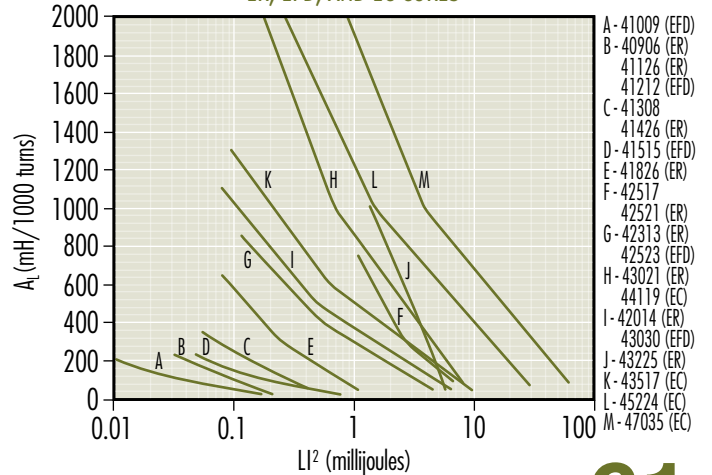

Inductor Design

DC BIAS DATA — FOR GAPPED APPLICATIONS

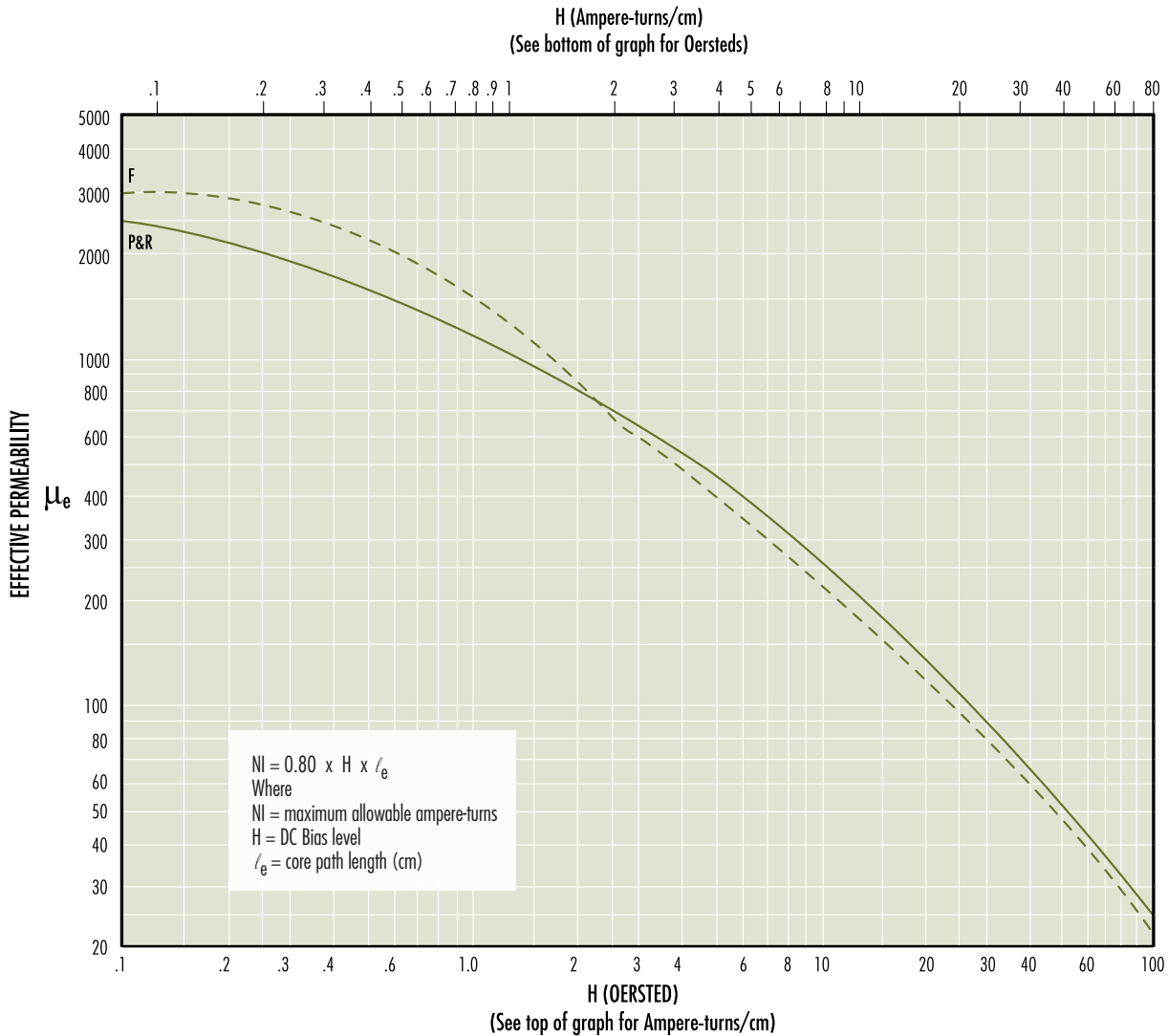

The above curves are limit curves, up to which *effective permeability* remains constant. They show the maximum allowable DC bias, in ampere-turns, without a reduction in inductance. Beyond this level (see insert), inductance drops rapidly.

Example: How many ampere-turns can be supported by an R42213A315 pot core without a reduction in inductance value?

$$l_e = 3.12 \text{ cm} \quad \mu_e = 125$$

Maximum allowable H = 25 Oersted (from the graph above)

NI (maximum) = $0.80 \times H \times l_e = 62.4$ ampere-turns
 or (Using top scale, maximum allowable H = 20 A-T/cm.)

$$\begin{aligned}
 \text{NI (maximum)} &= \text{A-T/cm} \times l_e \\
 &= 20 \times 3.12 \\
 &= 62.4 \text{ A-T}
 \end{aligned}$$

$$\mu_e = \frac{A_L \cdot l_e}{4 \pi A_e}$$

$$\frac{1}{\mu_e} = \frac{1}{\mu_i} + \frac{l_g}{l_e}$$

A_e = effective cross sectional area (cm²)
 A_L = inductance/1,000 turns (mH)
 μ_i = initial permeability
 l_g = gap length (cm)

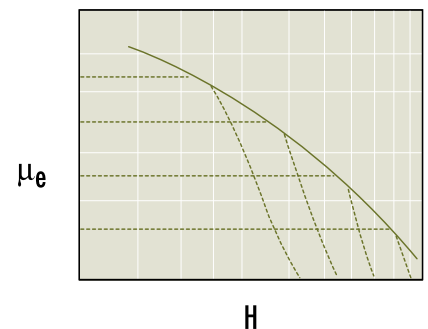

Inductance falls off rapidly above the limit curve. The dashed lines illustrate the μ_e curve for individual gapped core sets.

Transformer Design

Magnetics offers two methods to select a ferrite core for a power application.

CORE SELECTION BY POWER HANDLING CAPACITY

The Power Chart characterizes the power handling capacity of each ferrite core based upon the frequency of operation, the circuit topology, the flux level selected, and the amount of power required by the circuit. If these four specifics are known, the core can be selected from the Power Chart on page 64.

CORE SELECTION BY WaAc PRODUCT

The power handling capacity of a transformer core can also be determined by its WaAc product, where Wa is the available core window area, and Ac is the effective core cross-sectional area. Using the equation shown below, calculate the WaAc product and then use the Area Product Distribution (WaAc) Chart to select the appropriate core.

$$WaAc = \frac{P_o D_{cma}}{K_t B_{max} f}$$

WaAc = Product of window area and core area (cm⁴)

P_o = Power Out (watts)

D_{cma} = Current Density (cir. mils/amp) Current density can be selected depending upon the amount of heat rise allowed. 750 cir. mils/amp is conservative; 500 cir. mils is aggressive.

B_{max} = Flux Density (gauss) selected based upon frequency of operation. Above 20 kHz, core losses increase. To operate ferrite cores at higher frequencies, it is necessary to operate the core flux levels lower than ± 2 kg. The Flux Density vs. Frequency chart shows the reduction in flux levels required to maintain 100 mW/cm³ core losses at various frequencies, with a maximum temperature rise of 25°C. for a typical power material, MAGNETICS P.

A_c = Core area in cm²

V = Voltage

f = frequency (hertz)

I_p = Primary current

K_t = Topology constant

I_s = Secondary current

(for a space factor of 0.4)

N_p = Number of turns on the primary

N_s = Number of turns on the secondary

TOPOLOGY CONSTANTS K_t

Forward converter = 0.0005

Push-Pull = 0.001

Half-bridge = 0.0014

Full-bridge = 0.0014

Flyback = 0.00033 (single winding)

Flyback = 0.00025 (multiple winding)

For individual cores, WaAc is listed in this catalog under "Magnetic Data."

The WaAc formula was obtained from derivations in Chapter 7 of A. I. Pressman's book, "Switching Power Supply Design. Choice of B_{max} at various frequencies, D_{cma} and alternative transformer temperature rise calculations are also discussed in Chapter 7 of the Pressman book.

FLUX DENSITY VS. FREQUENCY P MATERIAL

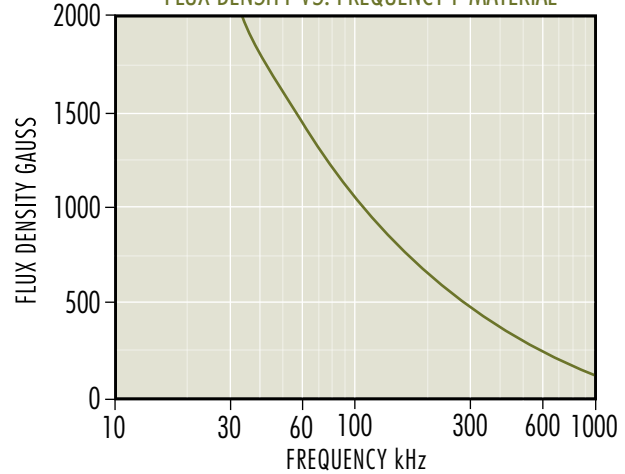

Once a core is chosen, the calculation of primary and secondary turns and wire size is readily accomplished.

$$N_p = \frac{V_p \times 10^8}{4BA_c f} \quad N_s = \frac{V_s}{V_p} N_p$$

$$I_p = \frac{P_{in}}{V_{in}} \quad I_s = \frac{P_{out}}{V_{out}}$$

$$KWA = N_p A_{wp} + N_s A_{ws}$$

Where

A_{wp} = primary wire area

A_{ws} = secondary wire area

Assume K = .4 for toroids; .6 for pot cores and E-U-I cores

Assume N_pA_{wp} = 1.1 N_sA_{ws} to allow for losses and feedback winding

$$\text{efficiency } e = \frac{P_{out}}{P_{in}} = \frac{P_{out}}{P_{out} + \text{wire losses} + \text{core losses}}$$

$$\text{Voltage Regulation (\%)} = \frac{IV_{no\ load} - IV_{full\ load}}{IV_{full\ load}} \times 100$$

Typical Power Handling Chart

Power in Watts				Pot, RS, DS	E Cores	RM, PQ, EP	UU, UI, UR	ETD, EER, EC	EFD, Planar	Toroid
20 kHz	50 kHz	100 kHz	250 kHz							
2	3	4	7	41811 RS DS PC	41205 EE 41707 EE	41313 EP 41812 RM 41912 RM			42107 EE 41805 EE	40907 TC 41406 TC 41303 TC 41435 TC 41304 TC 41206 TC 41506 TC 41407 TC 41405 TC 41305 TC
5	8	11	21	41814 PC 42311 RS DS HS	41808 EE	41717 EP 42013 RM 42016 PQ 42610 PQ			42019 EFD 42216 EI 43208 EI	41410 TC 41306 TC 41450 TC 41605 TC
12	18	27	52		41810 EE 42510 EE	42316 RM				
13	20	29	56	42213 PC		42614 PQ				41610 TC
15	22	32	62	42318 RS DS HS						
18	28	40	78			42020 PQ			42523 EFD	
19	30	42	83	42616 RS DS HS	42513 EE 42515 EI	42120 EP 43214 PQ	42515 UI		42216 EE 43618 EI 44008 EI	42106 TC 41809 TC
26	42	58	113						43208 EE	42206 TC
28	45	63	122		42520 EE				43030 EFD	
30	49	67	131	42616 RS PC		42620 PQ				42109 TC
33	53	74	144		42515 EE	42819 RM				42207 TC
40	61	90	175		42526 EE 43007 EE					
42	70	94	183	43019 HS		42625 PQ			43618 EE	
48	75	108	210	42823 PC 43019 RS DS PC	43009 EE		42512 UU 42515 UU	42929 ETD	44008 EE	42507 TC
60	97	135	262		42530 EE 43515 EE	43220 PQ		43517 EC	43808 EI	42212 TC
70	110	157	306	43622 DS HS		43723 RM	42220 UU 42530 UU	42814 EER 42817 EER 43434 ETD		42508 TC 42908 TC 42712 TC
105	160	235	460	43622 RS	44011 EE 44317 EE				44308 EI 44310 EI	
120	195	270	525	43622 PC		43230 PQ			43808 EE	43806 TC
130	205	290	570		43520 EE	44230 RM		44119 EC		
150	240	337	656		44016 EE 44020 EI			43521 EER 43939 ETD	44308 EE	43113 TC 42915 TC
190	300	470	917							
200	310	450	875						44310 EE	43610 TC

Typical Power Handling Chart

Power in Watts				Pot, RS, DS	E Cores	RM, PQ, EP	UU, UI, UR	ETD, EER, EC	EFD, Planar	Toroid
20 kHz	50 kHz	100 kHz	250 kHz							
220	350	495	962		44721 EE		44119 UR			
230	350	550	1073	44229 RS DS		43535 PQ	44121 UR	44013 EER		
260	400	585	1137							43813 TC
280	430	630	1225	44229 PC	44020 EE			44216 EER		
300	450	675	1312					44444 ETD 44818 EER 45224 EC	45810 EI	43615TC
340	550	765	1487		44033 EE		44125 UR			
360	580	810	1575		44022 EE	44040 PQ		45418 EER		43620 TC
410	650	922	1793		44033 EE 45724 EE		44130 UR	44821 EER 44949 ETD	46410 EI	44416 TC 44419 TC 43825 TC
550	800	1237	2406		46016 EE					44015 TC 44715 TC
650	1000	1462	2843			45050 PQ			45810 EE	
700	1100	1575	3062		45528 EE		45716 UR	45454 ETD	46410 EE	44920 TC 44916 TC
900	1500	2000	3900		45530 EE					44925 TC
1000	1600	2250	4375		47228 EE		45917 UR	45959 ETD 47035 EC		46013 TC 46113 TC
1400	2500	3200	6240							
1600	2600	3700	7215				46420 UR			44932 TC 46019 TC
2000	3000	4500	8750		46527 EE 47133 EE 48020 EE					46325 TC 46326 TC 47313 TC
2800	4200	6500	12675				49316 UI 49316 UU		49938 EE	47325 TC 48613 TC 48625TC 48626 TC 49715 TC 49718 TC
11700	19000	26500	51500		49928 EE		49330 UU 49332 UU 49920 UU 49925 UI 49925 UU			49725 TC 49740 TC

Ferrite Core selection listed by typical Power Handling Capabilities (Chart is for Power Ferrite Materials, F, P, R, L and T, Push-Pull Square wave operation)

Wattage values shown above are for push-pull converter design. De-rate by a factor of 3 or 4 for flyback. De-rate by a factor of 2 for feed-forward converter.
Example: For a feed-forward converter to be used at 300 watts select a core that is rated at 600 watts based on the converter topology.

Note: Assuming Core Loss to be Approximately 100 mW/cm³, B Levels Used in this Chart are:

@ 20 kHz - 200 mT, 2000 gauss; @ 50 kHz - 130 mT, 1300 gauss; @ 100 kHz - 90 mT, 900 gauss; @ 250 kHz - 70 mT, 700 gauss

Area Product Distribution (WaAc) Chart

WaAc (cm ²)	RS, DS, HS	E	EC, EER, EFD, ETD	EP, RM	ER	Planar	Pot	PQ	TC	U, UR
<0.001									40200 TC 40301 TC 40502 TC	
0.001									40401 TC 40402 TC 40503 TC 40601 TC	
0.002		40904 EE					40704 UG			
0.003					40906 EE		40905 UG		40603 TC	
0.004			41009 EFD		41126 EE					
0.005				40707 EP						
0.006					41308 EI		41107 UG			
0.008						41434 EI			40705 TC	
0.01			41212 EFD	41010 EP 41110 RM	41308 EE 41426 EE	41425 EE	41109 UG		41003 TC	41106 UI
0.02	41408 RS DS HS	41203 EE	41515 EFD	41510 RM		41434 EE	41408 UG		41005 TC	41106 UU
0.03		41205 EE 41707 EE		41313 EP	41826 EE	42107 EI 41805 EI			40907 TC	
0.04						41805 EI			41303 TC 41435 TC	
0.05	41811 HS			41812 RM	42313 EE				41206 TC 41304 TC 41405 TC 41407 TC 41506 TC	
0.06				41717 EP 41912 RM		42107 EE	41410 UG		41305 TC	
0.07	41811 RS DS				42014 EI	42107 EE 41805 EE	41811 UG	42610 UG	41306 TC 41406 TC	
0.08	42311 DS HS	41808EE			42517EI				41450TC	
0.09			42019 EFD				41814 UG			
0.1	42311 RS	41810 EE			42014 EE	42216 EI			41605 TC	
0.2	42318 RS DS HS	42510 EE 42515 EI	42523 EFD	42013 RM 42120 EP 42316 RM	42517 EE 43021 EI		42213 UG	42016 UG 42020 UG 42614 UG	41410 TC 41610TC	
0.3	42616 RS DS HS	42513 EE	43030 EFD		42521 EE 43225 EE	43618 EI 42216 EE		43214 UG	41809 TC 42106 TC	42515 UI
0.4		42526 EE		42819 RM		44008 EI 43208 EI	42616 UG	42620 UG	42109 TC 42206 TC	
0.5		42520 EE 43007 EE	42814 EER		43021 EE				42207 TC	
0.6	43019 DS HS	42515 EE 43009 EE				43618 EE	42823 UG	42625 UG		42220 UU 42515 UU
0.7	43019 RS	42530 EE	42929 EFD 42817 EER			43208 EE	43019 UG		42507 TC	
0.8			43517 EC			44008 EE		43220 UG	42212 TC	42512 UU
0.9						43808 EI			42508 TC	

Area Product Distribution (WaAc) Chart

WaAc (cm ²)	RS, DS, HS	E	EC, EER, EFD, ETD	EP, RM	ER	Planar	Pot	PQ	TC	U, UR
1	43622 RS DS HS	43515 EE 44011 EE 44020 EI	43434 ETD	43723 RM		44308 EI			42712 TC 42908 TC	42530 UU
2		44016 EE 44317 EE 43520 EE	43521 EER 43939 ETD 44013 EER 44119 EC	44230 RM		43808 EE 44310 EI	43622 UG	43230 UG	42915 TC 43113 TC 43806 TC	
3	44229 RS DS	44721 EE	44216 EER 44818 EER			44308 EE 44310 EE		43535 UG	43610 TC 43813 TC	44119 UR 44121 UR
4		44020 EE 44022 EE	44444 ETD 44821 EER 45224 EC 45418 EER			45810 EI	44229 UG		43615 TC	44125 UR
5								44040 UG	43620 TC 44416 TC	44130 UR
6		44033 EE 46016 EE	44949 ETD			46410 EI			44419 TC	
7		45724 EE							43825 TC 44015 TC	
8						45810 EE		45050 UG	44715 TC	
9			45454 ETD						44920 TC	45716 UR
10		45528 EE								
11						46410 EE			44916 TC	
12		45530 EE								
13			47035 EC						44925 TC	
14			45959 ETD							45917 UR
15		47228 EE								
16									46013 TC 46113 TC	
21									44932 TC	
22										46420 UU
23		47133 EE								
24		46527 EE								
25									46019 TC 47313 TC	
32		48020 EE								
33									46325 TC	
34									46326 TC	
46									48613 TC	49316 UI
50									47325 TC	
51						49938 EE				
61										49925 UI
90		49928 EE								
91									48625 TC 48626 TC 49715 TC	49316 UU
106									49718 TC	
121										49925 UU
171									49725 TC	
286										49920 UU
372									49740 TC	

Website

For updates and more in-depth product information, visit mag-inc.com or mag-inc.com.cn

- Design Equations
- Area Product Distribution (WaAc) and Power Charts
- Product Datasheets
- Product Catalogs
- Design Software
- Distributor Stock Check
- Part Number Search
- Cross Reference Tool



Other Products from Magnetics



POWDER CORES

Powder cores are excellent as low loss inductors for switched-mode power supplies, switching regulators and noise filters. Most core types can be shipped immediately from stock.

Kool M μ [®] powder cores have a higher energy storage capacity than MPP cores and are available in six permeabilities from 14 μ through 125 μ . Kool M μ is available in a variety of core types, for maximum flexibility. Toroids offer compact size and self-shielding. E cores and U cores afford lower cost of winding, use of foil inductors, and ease of fixturing. Very large cores and structures are available to support very high current applications. These include toroids and racetrack shapes up to 102 mm, 133 mm and 165 mm; jumbo E cores; stacked shapes; and blocks.

Molypermalloy powder cores (MPP) are available in ten permeabilities ranging from 14 through 550, and have guaranteed inductance limits of $\pm 8\%$. Insulation on the cores is a high dielectric strength finish not affected by normal potting compounds and waxes. Thirty sizes include I.D.s from 0.070" (1.78 mm) to 4.032" (102.4 mm) and O.D.s from 0.140" (3.56 mm) to 6.5" (165.1 mm). Standard cores include either temperature stabilized (as wide as -65° C to 125° C for stable operation) or standard stabilization.

High Flux powder cores have a much higher energy storage capacity than MPP cores and are available in six permeabilities from 14 μ through 160 μ . High Flux cores are available in sizes identical to MPP cores.

Magnetics **XFlux**[®] distributed air gap cores are made from 6.5% silicon iron powder and are available in 26 μ and 60 μ . A true high temperature material, with no thermal aging, XFlux[®] offers lower losses than powder iron cores and superior DC Bias performance. The soft saturation of XFlux[®] material offers an advantage over ferrite cores. XFlux[®] cores are ideal for low and medium frequency chokes where inductance at peak current is critical. Toroids are available in sizes up to 133 mm and blocks with lengths of 50, 60, and 80 mm.

Magnetics **AmoFlux**[®] is a new powder alloy distributed gap material that is ideal for power factor correction (PFC) and output chokes. This alloy starts with low core loss ribbon that is pulverized into powder and then pressed into a toroid. By converting the ribbon into a powder, the resulting AmoFlux cores have the same excellent properties, including soft saturation, as Magnetics other powder core materials: Kool M μ [®], MPP, High Flux, and XFlux[®]. What makes this amorphous powder core material unique is the combination of low core loss and high DC bias. These attributes make AmoFlux an excellent choice for computer, server, and industrial power supplies that require PFC or output chokes.



TAPE WOUND CORES

Tape wound cores are made from high permeability alloys of nickel-iron, cobalt-iron, and grain oriented silicon-iron. The alloys are known as Orthonal[®], Alloy 48, Square Permalloy 80, Supermalloy, Supermendur and Magnesil[®]. Cores are available in more than 50 standard sizes. For a wide range of frequency applications, materials are produced in thicknesses from 1/2 mil (0.013 mm) through 4 mils (0.102 mm). Cases are robust nylon and aluminum boxes, rated for 200° C continuous operation and 2,000 voltage minimum breakdown. Applications include: magnetic amplifiers, reactors, regulators, static magnetic devices and current transformers.

Miniature Tape Wound Bobbin Cores are manufactured from Permalloy 80 and Orthonal ultra-thin tape (0.000125" to 0.001" thick). They are available in widths from 0.031" to 0.250" (wider on special request). Wound on non-magnetic stainless steel bobbins, core diameters are available down to 0.159", with flux capacities as low as several Maxwells. Magnetics' sophisticated pulse test equipment reproduces most test programs and can measure accurately in the millivoltmicrosecond region. Applications include: magnetometers, flux gates, oscillators, inverters and magnetic amplifiers.

NEW
AmoFlux[®]



P.O. Box 11422
Pittsburgh PA, 15238
(p) 1.412.696.1333
1.800.245.3984
magnetics@spang.com

MAGNETICS
INTERNATIONAL SALES
(p) +852.3102.9337
+86.13911471417
asiasales@spang.com

www.mag-inc.com
www.mag-inc.com.cn

