

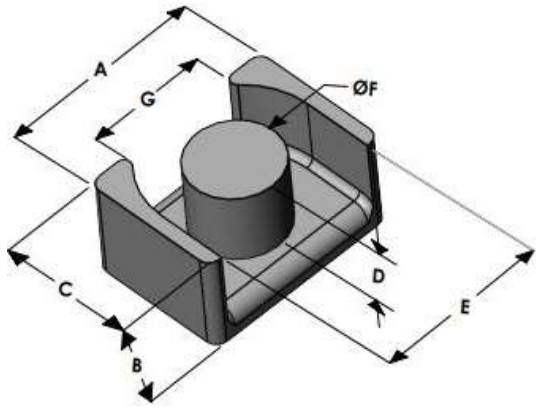

LPY4225E060L123

110 Delta Drive
 Pittsburgh, PA 15238
 NAFTA Sales: (1)800-245-3984
 HK Sales : (852)3102-9337
 magnetics@spang.com
 www.mag-inc.com



Kool M μ MAX Permeability (μ)	A _L (nH/T ²)	Core Marking	
		Lot Number	Part Number
60	218 ± 8%	XXXXXX	LPY4225E060L123

	Dimensions		Tolerance (±)		Packaging
	(mm)	(in)	(mm)	(in)	
A	42.00	1.653	0.50	0.020	Box Qty= 180 Pcs
B	12.30	0.484	0.20	0.008	
C	25.00	0.984	0.30	0.012	
D	7.90	0.311	0.20	0.008	Available Hardware
E	35.20	1.385	0.40	0.016	
F	16.20	0.638	0.30	0.012	
G	27.25	1.072	0.35	0.014	

Electrical Characteristics			Physical Characteristics					
Watt Loss @ 100 kHz, 100mT max (mW/cm ³)	DC Bias min (oersteds)		Break Strength typ (kg)	Window Area W _a (mm ²)	Cross Section A _e (mm ²)	Path Length L _e (mm)	Volume V _e (mm ³)	Est. Weight (Ea. Piece) (g)
775	80%	50%	53	150	206	76.1	15,680	TBD
	45	100						

Note: Standard AL is controlled with full window high turns test coils. Application coils with few turns often result in lower inductance than expected, or sometimes higher.

Notes:	Temperature Rating
	Curie Temp: 500 °C

