

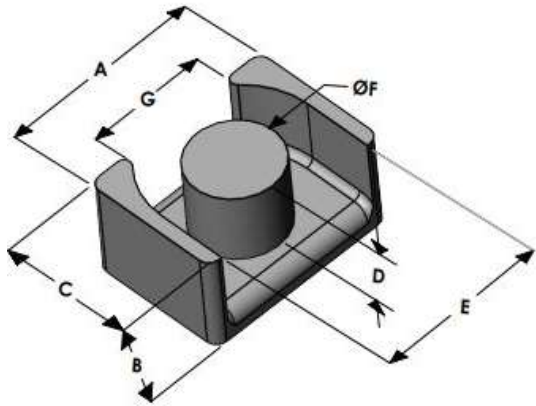

# LPY2314E060L087

110 Delta Drive  
 Pittsburgh, PA 15238  
 NAFTA Sales: (1)800-245-3984  
 HK Sales : (852)3102-9337  
 magnetics@spang.com  
 www.mag-inc.com



Kool M $\mu$ MAX Permeability ( $\mu$ )	A <sub>L</sub> (nH/T <sup>2</sup> )	Core Marking	
		Lot Number	Part Number
60	110 ± 8%	XXXXXX	LPY2314E060L087

	Dimensions		Tolerance (±)		Packaging
	(mm)	(in)	(mm)	(in)	
A	23.39	0.921	0.30	0.012	Box Qty= 630 Pcs
B	8.71	0.343	0.20	0.008	
C	14.00	0.551	0.20	0.008	
D	6.20	0.244	0.20	0.008	Available Hardware
E	19.41	0.764	0.20	0.008	
F	9.19	0.362	0.20	0.008	
G					

Electrical Characteristics			Physical Characteristics					
Watt Loss @ 100 kHz, 100mT max (mW/cm <sup>3</sup> )	DC Bias min (oersteds)		Break Strength typ (kg)	Window Area W <sub>a</sub> (mm <sup>2</sup> )	Cross Section A <sub>e</sub> (mm <sup>2</sup> )	Path Length L <sub>e</sub> (mm)	Volume V <sub>e</sub> (mm <sup>3</sup> )	Est. Weight (Ea. Piece) (g)
775	80%	50%	27	63.4	67.0	49.1	3,290	TBD
	45	100						

Note: Standard AL is controlled with full window high turns test coils. Application coils with few turns often result in lower inductance than expected, or sometimes higher.

Notes:	Temperature Rating
	Curie Temp: 500 °C

