

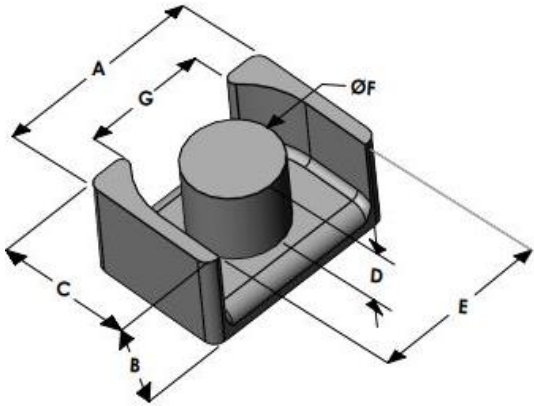

LPG3624E026L144

110 Delta Drive
 Pittsburgh, PA 15238
 NAFTA Sales: (1)800-245-3984
 HK Sales : (852)3102-9337
 magnetics@spang.com
 www.mag-inc.com



Edge Permeability (μ)	A_L (nH/T ²)	Core Marking	
		Lot Number	Part Number
26	86 ± 8%	XXXXXX	LPG3624E026L144

	Dimensions		Tolerance (±)		Packaging
	(mm)	(in)	(mm)	(in)	
A	36.20	1.425	0.40	0.016	Est. Box Qty= 240 Pcs
B	14.40	0.567	0.20	0.008	
C	24.00	0.945	0.30	0.012	
D	10.40	0.409	0.20	0.008	Available Hardware
E	30.40	1.196	0.40	0.016	
F	15.00	0.590	0.20	0.008	
G	22.28	0.877	0.30	0.012	

Electrical Characteristics			Physical Characteristics					
Watt Loss @ 100 kHz, 100mT max (mW/cm ³)	DC Bias min (oersteds)		Break Strength typ (kg)	Window Area W_a (mm ²)	Cross Section A_e (mm ²)	Path Length L_e (mm)	Volume V_e (mm ³)	Est. Weight (Ea. Piece) (g)
550	80%	50%	50	160	177	80.6	14,270	TBD
	210	325						

Note: Standard AL is controlled with full window high turns test coils. Application coils with few turns often result in lower inductance than expected, or sometimes higher.

Notes:	Temperature Rating
	Curie Temp: 500 °C

Typical DC Bias Performance

