

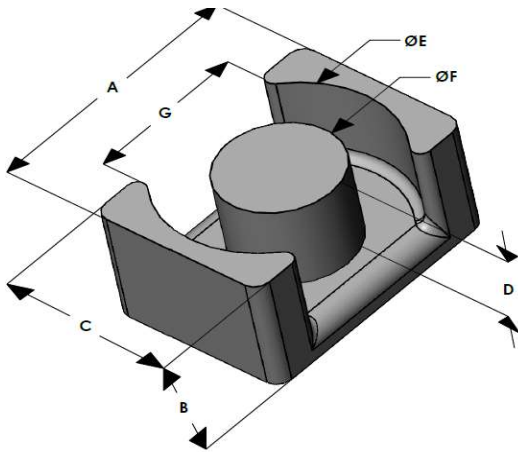

# EQY2014E040L050

110 Delta Drive  
 Pittsburgh, PA 15238  
 NAFTA Sales: (1)800-245-3984  
 HK Sales : (852)3102-9337  
 magnetics@spang.com  
 www.mag-inc.com



Kool M $\mu$ MAX Permeability ( $\mu$ )	A <sub>L</sub> (nH/T <sup>2</sup> )	Core Marking	
		Lot Number	Part Number
40	120 ± 8%	XXXXXX	EQY2014E040L050

	Dimensions		Tolerance (±)			Packaging
	(mm)	(in)	(mm)	(in)		
A	20.00	0.787	0.30	0.012		Box Qty= 1596 Pcs
B	5.00	0.197	0.20	0.008		
C	14.00	0.551	0.20	0.008		
D	2.60	0.102	0.20	0.008		Available Hardware
E	18.00	0.708	0.20	0.008		
F	8.80	0.346	0.20	0.008		
G	13.00	0.512	-	-	Min	

Electrical Characteristics			Physical Characteristics					
Watt Loss @ 100 kHz, 100mT max (mW/cm <sup>3</sup> )	DC Bias min (oersteds)		Break Strength typ (kg)	Window Area W <sub>a</sub> (mm <sup>2</sup> )	Cross Section A <sub>e</sub> (mm <sup>2</sup> )	Path Length L <sub>e</sub> (mm)	Volume V <sub>e</sub> (mm <sup>3</sup> )	Est. Weight (Ea. Piece) (g)
775	80%	50%	34	23.9	60.8	29.3	1,780	TBD
	80	145						

Note: Standard AL is controlled with full window high turns test coils. Application coils with few turns often result in lower inductance than expected, or sometimes higher.

Notes:	Temperature Rating
	Curie Temp: 500 °C

## Typical DC Bias Performance

