

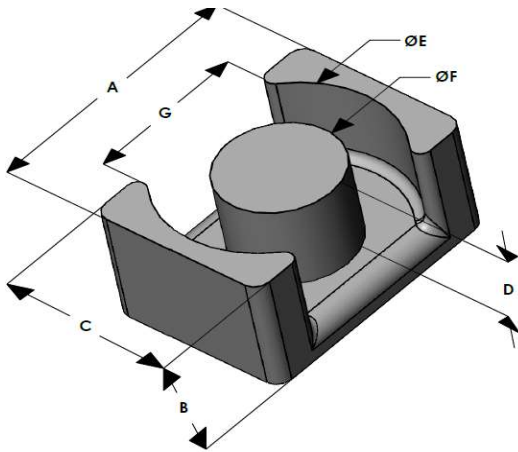

# EQX3626E060L100

110 Delta Drive  
 Pittsburgh, PA 15238  
 NAFTA Sales: (1)800-245-3984  
 HK Sales : (852)3102-9337  
 magnetics@spang.com  
 www.mag-inc.com



XFlux Permeability ( $\mu$ )	$A_L$ (nH/T <sup>2</sup> )	Core Marking	
		Lot Number	Part Number
60	224 ± 8%	XXXXXX	EQX3626E060L100

	Dimensions		Tolerance (±)		Packaging	
	(mm)	(in)	(mm)	(in)		
<b>A</b>	36.00	1.417	0.40	0.016	Box Qty= 210 Pcs	
<b>B</b>	10.00	0.394	0.20	0.008		
<b>C</b>	26.00	1.023	0.30	0.012		
<b>D</b>	6.00	0.236	-	-	Nom	Available Hardware
<b>E</b>	32.00	1.259	0.30	0.012		
<b>F</b>	14.40	0.567	0.20	0.008		
<b>G</b>	22.30	0.878	0.30	0.012		

Electrical Characteristics			Physical Characteristics					
Watt Loss @ 50kHz, 100mT max (mW/cm <sup>3</sup> )	DC Bias min (oersteds)		Break Strength typ (kg)	Window Area $W_a$ (mm <sup>2</sup> )	Cross Section $A_e$ (mm <sup>2</sup> )	Path Length $L_e$ (mm)	Volume $V_e$ (mm <sup>3</sup> )	Est. Weight (Ea. Piece) (g)
	80%	50%						
550	70	130	32	106	181	65.1	11,800	39

Note: Standard AL is controlled with full window high turns test coils. Application coils with few turns often result in lower inductance than expected, or sometimes higher.

Notes:	Temperature Rating
	Curie Temp: 700 °C

