

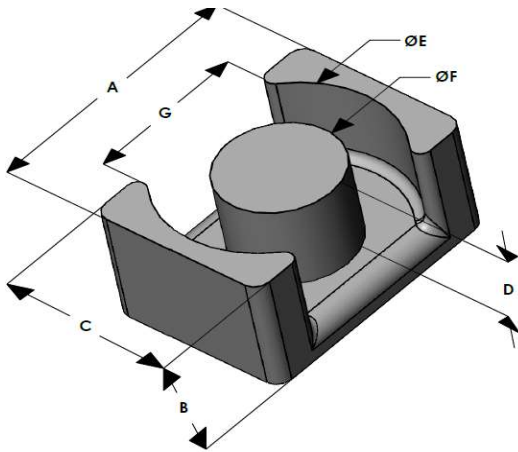

# EQX2014E026L061

110 Delta Drive  
 Pittsburgh, PA 15238  
 NAFTA Sales: (1)800-245-3984  
 HK Sales : (852)3102-9337  
 magnetics@spang.com  
 www.mag-inc.com



XFlux Permeability ( $\mu$ )	$A_L$ (nH/T <sup>2</sup> )	Core Marking	
		Lot Number	Part Number
26	67 ± 8%	XXXXXX	EQX2014E026L061

	Dimensions		Tolerance (±)			Packaging
	(mm)	(in)	(mm)	(in)		
<b>A</b>	20.00	0.787	0.30	0.012		Box Qty= 1596 Pcs
<b>B</b>	6.10	0.240	0.20	0.008		
<b>C</b>	14.00	0.551	0.20	0.008		
<b>D</b>	3.70	0.146	0.30	0.012		Available Hardware
<b>E</b>	18.00	0.708	0.20	0.008		
<b>F</b>	8.80	0.346	0.20	0.008		
<b>G</b>	13.00	0.512	-	-	Min	

Electrical Characteristics			Physical Characteristics					
Watt Loss @ 50kHz, 100mT max (mW/cm <sup>3</sup> )	DC Bias min (oersteds)		Break Strength typ (kg)	Window Area $W_a$ (mm <sup>2</sup> )	Cross Section $A_e$ (mm <sup>2</sup> )	Path Length $L_e$ (mm)	Volume $V_e$ (mm <sup>3</sup> )	Est. Weight (Ea. Piece) (g)
425	80%	50%	34	34.1	60.8	35.8	2,180	6
	140	250						

Note: Standard AL is controlled with full window high turns test coils. Application coils with few turns often result in lower inductance than expected, or sometimes higher.

Notes:	Temperature Rating
	Curie Temp: 700 °C

