

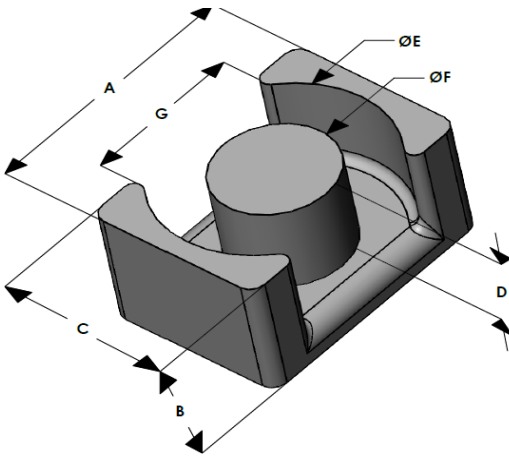

EQK5032E040L250

110 Delta Drive
 Pittsburgh, PA 15238
 NAFTA Sales: (1)800-245-3984
 HK Sales : (852)3102-9337
 magnetics@spang.com
 www.mag-inc.com



Kool M μ Permeability (μ)	A _L (nH/T ²)	Core Marking	
		Lot Number	Part Number
40	136 ± 8%	XXXXXX	EQK5032E040L250

	Dimensions		Tolerance (±)		Packaging
	(mm)	(in)	(mm)	(in)	
A	50.00	1.968	0.60	0.024	Est. Box Qty= 80 Pcs
B	25.00	0.984	0.40	0.016	
C	32.00	1.259	0.40	0.016	
D	19.50	0.767	0.20	0.008	Available Hardware
E	44.00	1.732	0.50	0.020	
F	20.00	0.787	0.30	0.012	
G					

Electrical Characteristics			Physical Characteristics					
Watt Loss @ 100 kHz, 100mT max (mW/cm ³)	DC Bias min (oersteds)		Break Strength typ (kg)	Window Area W _a (mm ²)	Cross Section A _e (mm ²)	Path Length L _e (mm)	Volume V _e (mm ³)	Est. Weight (Ea. Piece) (g)
	80%	50%						
550	60	120	120	468	314	133	41,900	TBD

Note: Standard AL is controlled with full window high turns test coils. Application coils with few turns often result in lower inductance than expected, or sometimes higher.

Notes:	Temperature Rating
	Curie Temp: 500 °C

