

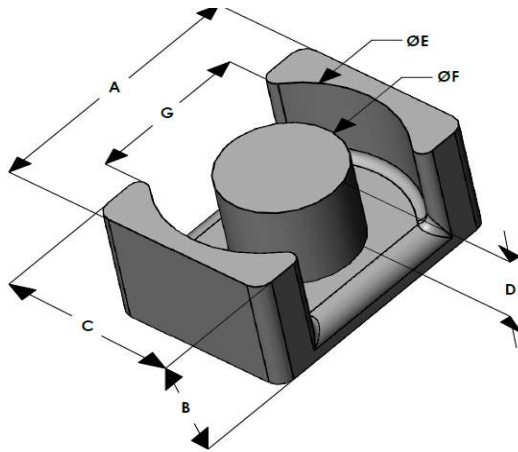

EQK3626E040L100

110 Delta Drive
 Pittsburgh, PA 15238
 NAFTA Sales: (1)800-245-3984
 HK Sales : (852)3102-9337
 magnetics@spang.com
 www.mag-inc.com



Kool M μ Permeability (μ)	A _L (nH/T ²)	Core Marking	
		Lot Number	Part Number
40	160 ± 8%	XXXXXX	EQK3626E040L100

	Dimensions		Tolerance (±)		Packaging	
	(mm)	(in)	(mm)	(in)		
A	36.00	1.417	0.40	0.016	Box Qty= 210 Pcs	
B	10.00	0.394	0.20	0.008		
C	26.00	1.023	0.30	0.012		
D	6.00	0.236	-	-	Nom	Available Hardware
E	32.00	1.259	0.30	0.012		
F	14.40	0.567	0.20	0.008		
G	22.30	0.878	0.30	0.012		

Electrical Characteristics			Physical Characteristics					
Watt Loss @ 100 kHz, 100mT max (mW/cm ³)	DC Bias min (oersteds)		Break Strength typ (kg)	Window Area W _a (mm ²)	Cross Section A _e (mm ²)	Path Length L _e (mm)	Volume V _e (mm ³)	Est. Weight (Ea. Piece) (g)
	80%	50%						
550	60	120	32	106	181	65.1	11,800	33

Note: Standard AL is controlled with full window high turns test coils. Application coils with few turns often result in lower inductance than expected, or sometimes higher.

Notes:	Temperature Rating
	Curie Temp: 500 °C

Typical DC Bias Performance

