

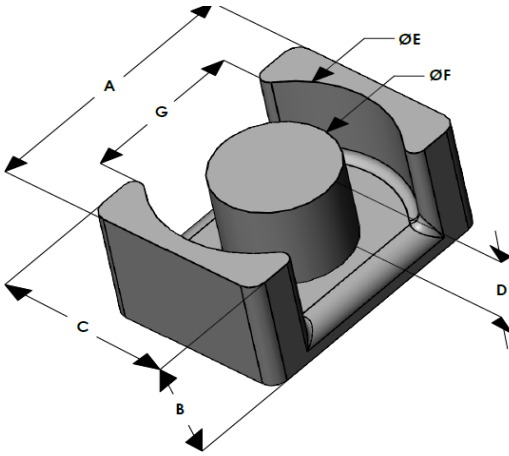

EQH5032E040L200

110 Delta Drive
 Pittsburgh, PA 15238
 NAFTA Sales: (1)800-245-3984
 HK Sales : (852)3102-9337
 magnetics@spang.com
 www.mag-inc.com



High Flux Permeability (μ)	A_L (nH/T ²)	Core Marking	
		Lot Number	Part Number
40	160 ± 8%	XXXXXX	EQH5032E040L200

	Dimensions		Tolerance (±)		Packaging
	(mm)	(in)	(mm)	(in)	
A	50.00	1.968	0.60	0.024	Est. Box Qty= 80 Pcs
B	20.00	0.787	0.40	0.016	
C	32.00	1.259	0.40	0.016	
D	14.50	0.571	0.40	0.016	Available Hardware
E	44.00	1.732	0.50	0.020	
F	20.00	0.787	0.30	0.012	
G					

Electrical Characteristics			Physical Characteristics					
Watt Loss @ 100 kHz, 100mT max (mW/cm ³)	DC Bias min (oersteds)		Break Strength typ (kg)	Window Area W_a (mm ²)	Cross Section A_e (mm ²)	Path Length L_e (mm)	Volume V_e (mm ³)	Est. Weight (Ea. Piece) (g)
	80%	50%						
850	120	190	120	348	314	113	35,600	TBD

Note: Standard AL is controlled with full window high turns test coils. Application coils with few turns often result in lower inductance than expected, or sometimes higher.

Notes:	Temperature Rating
	Curie Temp: 500 °C

