

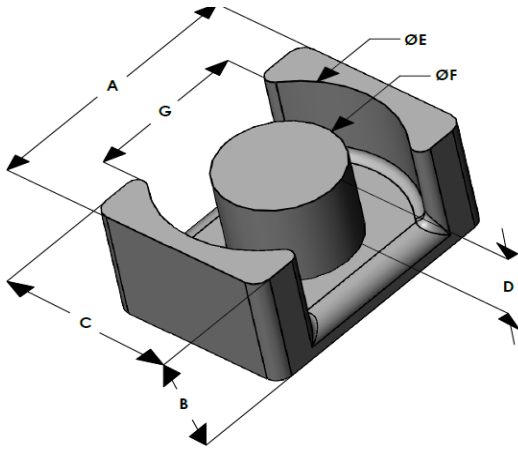

EQG4128E060L199

110 Delta Drive
 Pittsburgh, PA 15238
 NAFTA Sales: (1)800-245-3984
 HK Sales : (852)3102-9337
 magnetics@spang.com
 www.mag-inc.com



Edge Permeability (μ)	A_L (nH/T ²)	Core Marking	
		Lot Number	Part Number
60	140 ± 8%	XXXXXX	EQG4128E060L199

	Dimensions		Tolerance (±)		Packaging
	(mm)	(in)	(mm)	(in)	
A	41.50	1.633	0.40	0.016	Est. Box Qty= 140 Pcs
B	19.90	0.783	0.20	0.008	
C	28.00	1.102	0.30	0.012	
D	15.40	0.606	0.20	0.008	Available Hardware
E	36.50	1.436	0.30	0.012	
F	14.90	0.586	0.20	0.008	
G	26.60	1.047	0.30	0.012	

Electrical Characteristics		Physical Characteristics						
Watt Loss @ 100 kHz, 100mT max (mW/cm ³)	DC Bias min (oersteds)		Break Strength typ (kg)	Window Area W_a (mm ²)	Cross Section A_e (mm ²)	Path Length L_e (mm)	Volume V_e (mm ³)	Est. Weight (Ea. Piece) (g)
550	80%	50%	45	333	200	115	23,000	TBD
	105	160						

Note: Standard AL is controlled with full window high turns test coils. Application coils with few turns often result in lower inductance than expected, or sometimes higher.

Notes:	Temperature Rating
	Curie Temp: 500 °C

Typical DC Bias Performance

