

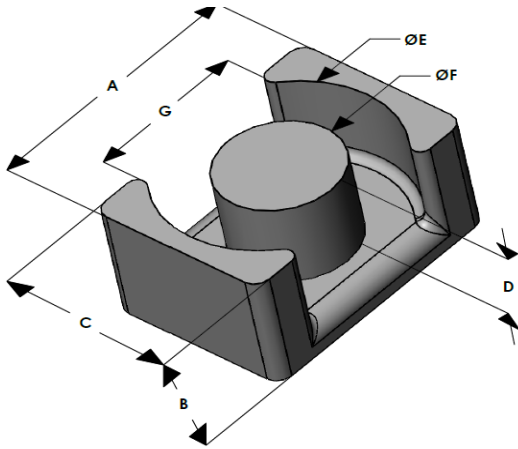

# EQG2619E026L124

110 Delta Drive  
 Pittsburgh, PA 15238  
 NAFTA Sales: (1)800-245-3984  
 HK Sales : (852)3102-9337  
 magnetics@spang.com  
 www.mag-inc.com



Edge Permeability ( $\mu$ )	$A_L$ (nH/T <sup>2</sup> )	Core Marking	
		Lot Number	Part Number
26	74 ± 8%	XXXXXX	EQG2619E026L124

	Dimensions		Tolerance (±)		Packaging
	(mm)	(in)	(mm)	(in)	
<b>A</b>	26.50	1.043	0.20	0.008	Est. Box Qty= 250 Pcs
<b>B</b>	12.40	0.488	0.15	0.006	
<b>C</b>	19.00	0.748	0.20	0.008	
<b>D</b>	9.10	0.358	0.15	0.006	<b>Available Hardware</b>
<b>E</b>	22.60	0.889	0.30	0.012	
<b>F</b>	12.00	0.472	0.20	0.008	
<b>G</b>	15.00	0.590	-	-	<b>Min</b>

Electrical Characteristics			Physical Characteristics					
Watt Loss @ 100 kHz, 100mT max (mW/cm <sup>3</sup> )	DC Bias min (oersteds)		Break Strength typ (kg)	Window Area $W_a$ (mm <sup>2</sup> )	Cross Section $A_e$ (mm <sup>2</sup> )	Path Length $L_e$ (mm)	Volume $V_e$ (mm <sup>3</sup> )	Est. Weight (Ea. Piece) (g)
	80%	50%						
550	210	325	34	96.5	120	63.9	7,650	TBD

Note: Standard AL is controlled with full window high turns test coils. Application coils with few turns often result in lower inductance than expected, or sometimes higher.

Notes:	Temperature Rating
	Curie Temp: 500 °C

## Typical DC Bias Performance

