

DIMENSIONS

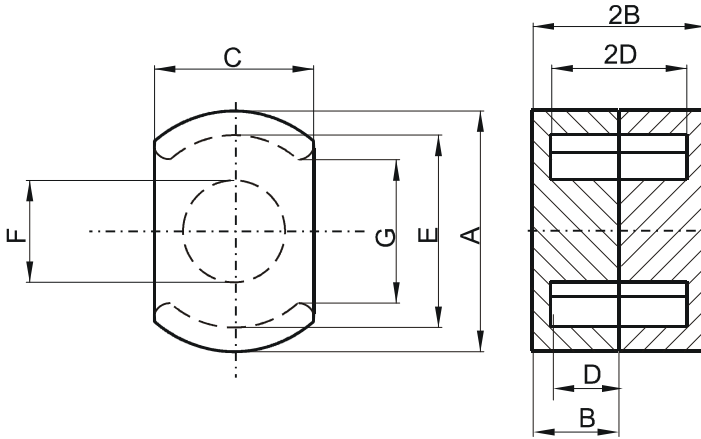

(mm)	Nominal:	Tol. min.:	Tol. max.:
A	30.0	-0.51	+ 0.51
B	9.4	-0.1	+ 0.1
2B	18.8	-0.2	+ 0.2
C	20.32	-0.25	+ 0.25
D	6.5 Min.		
2D	13.0 Min.		
E	25.0 Min.		
F	13.51 Max.		
G	15.49 Min.		
Eff. Parameters			
Ae mm²	Amin mm²	le mm	Ve mm³
117.0	96.0	46.2	5410

INDUCTANCE

AL value (nH)	Test conditions
Nom: 15000 Min.: 10500	10 kHz, < 0.5 mT, 25 °C

MARKING

No marking

LOSS FACTOR

$\tan \delta/\mu$ ($\times 10^{-6}$)	Test conditions
< 3.5	10 kHz, < 0.25 mT, 25 °C
< 50	100 kHz, < 0.25 mT, 25 °C

NOTE

Spec. modifications	Previous	Revised
2005-06-22	Loss factor: General W material Marking	Loss factor: Detail as indicated No marking