

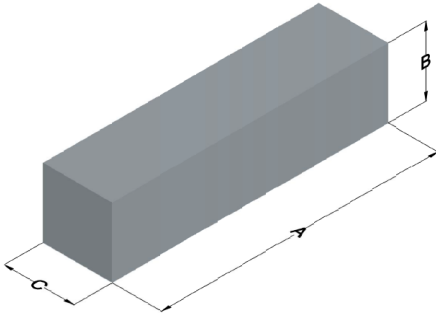

# 00X7030B040

110 Delta Drive  
 Pittsburgh, PA 15238  
 NAFTA Sales: (1)800-245-3984  
 HK Sales : (852)3102-9337  
 magnetics@spang.com  
 www.mag-inc.com



XFLUX Permeability ( $\mu$ )	Core Marking	
	Lot Number	Part number
40	XXXXXX	X7030B040

	Dimensions		Tolerance ( $\pm$ )		Packaging
	(mm)	(in)	(mm)	(in)	
<b>A</b>	70.5	2.776	0.50	0.020	Cardboard cut-outs Box Qty= 60 pcs
<b>B</b>	30.3	1.193	0.30	0.012	
<b>C</b>	20.0	0.787	0.20	0.008	

Physical Characteristics		Temperature Rating	Note:
Volume $V_e$ (mm <sup>3</sup> )	Weight (g)	Curie Temp: 700°C	Cosmetic Standard: Magnetics' Xflux shapes criteria for appearance.
42,800	230		

