

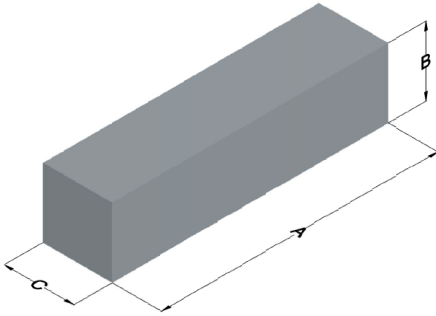

00X6030B040

110 Delta Drive
 Pittsburgh, PA 15238
 NAFTA Sales: (1)800-245-3984
 HK Sales : (852)3102-9337
 magnetics@spang.com
 www.mag-inc.com



XF _{LUX} Permeability (μ)	Core Marking	
	Lot Number	Part number
40	XXXXXX	X6030B040

	Dimensions		Tolerance (±)		Packaging
	(mm)	(in)	(mm)	(in)	
A	60.00	2.362	0.51	0.020	Cardboard cut-outs Box Qty= 80 pcs
B	30.00	1.181	0.51	0.020	
C	15.0	0.591	0.26	0.010	

Physical Characteristics		Temperature Rating	Note:
Volume V _e (mm ³)	Weight (g)	Curie Temp: 700°C	Cosmetic Standard: Magnetics' Xflux shapes criteria for appearance.
27,000	170		

