

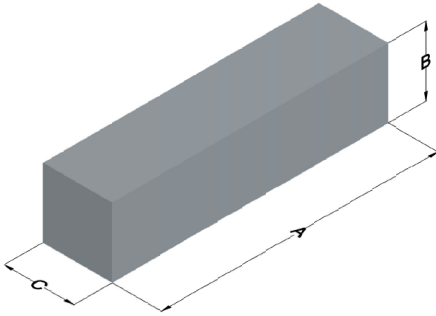

00X5030B060

110 Delta Drive
 Pittsburgh, PA 15238
 NAFTA Sales: (1)800-245-3984
 HK Sales : (852)3102-9337
 magnetics@spang.com
 www.mag-inc.com



XF _{LUX} Permeability (μ)	Core Marking	
	Lot Number	Part number
60	XXXXXX	X5030B060

	Dimensions		Tolerance (±)		Packaging
	(mm)	(in)	(mm)	(in)	
A	50.50	1.988	0.50	0.020	Cardboard cut-outs Box Qty= 64 pcs
B	30.30	1.193	0.30	0.012	
C	15.0	0.591	0.20	0.008	

Physical Characteristics		Temperature Rating	Note:
Volume V _e (mm ³)	Weight (g)	Curie Temp: 700°C	Cosmetic Standard: Magnetics' Xflux shapes criteria for appearance.
23,000	150		

