

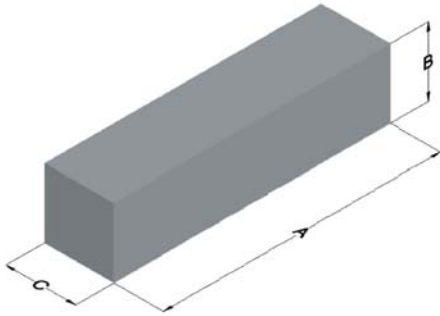

00X4741B040

110 Delta Drive
 Pittsburgh, PA 15238
 NAFTA Sales: (1)800-245-3984
 HK Sales : (852)3102-9337
 magnetics@spang.com
 www.mag-inc.com



XFLUX Permeability (μ)	Core Marking	
	Lot Number	Part number
40	XXXXXX	X4741B040

	Dimensions		Tolerance (\pm)		Packaging
	(mm)	(in)	(mm)	(in)	
A	47.50	1.870	0.61	0.024	Cardboard cut-outs Box Qty= 48 pcs
B	41.00	1.614	0.51	0.020	
C	27.51	1.083	0.41	0.016	

Physical Characteristics		Temperature Rating	Note:
Volume V_e (mm ³)	Weight (g)	Curie Temp: 700°C	Cosmetic Standard: Magnetix' Xflux shapes criteria for appearance.
53,600	340		

