

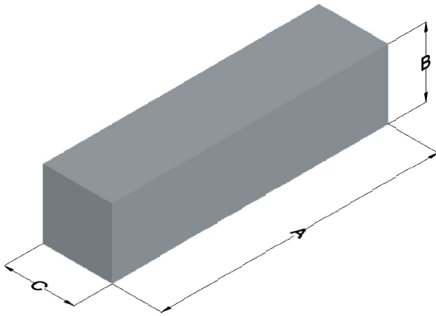

PRELIMINARY
00K9541B060

110 Delta Drive
Pittsburgh, PA 15238
NAFTA Sales: (1)800-245-3984
HK Sales : (852)3102-9337
magnetics@spang.com
www.mag-inc.com



Kool M μ Permeability (μ)	Core Marking	
	Lot Number	Part number
60	XXXXXX	K9541B060

	Dimensions		Tolerance (\pm)		Packaging
	(mm)	(in)	(mm)	(in)	
A	95.00	3.740	0.61	0.024	Cardboard cut-outs Box Qty= 30 pcs
B	41.00	1.614	0.51	0.020	
C	27.51	1.083	0.41	0.016	

Physical Characteristics		Temperature Rating	Note:
Volume V _e (mm ³)	Weight (g)	Curie Temp: 500°C	Cosmetic Standard: Magnetics' Kool M μ shapes criteria for appearance.
107,200	620		

