

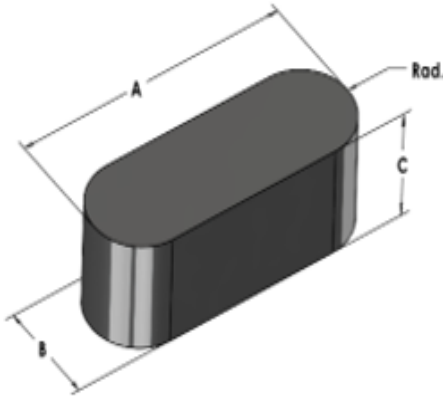

00K6034R060

110 Delta Drive
 Pittsburgh, PA 15238
 NAFTA Sales: (1)800-245-3984
 HK Sales : (852)3102-9337
 magnetics@spang.com
 www.mag-inc.com



Kool M μ Permeability (μ)	Core Marking	
	Lot Number	Part Number
60	XXXXXX	K6034R060

	Dimensions		Tolerance (\pm)			Packaging
	(mm)	(in)	(mm)	(in)		
A	60.00	2.362	0.50	0.020		Box Qty = 128
B	34.00	1.339	0.30	0.012		
C	10.00	0.394	0.20	0.008		
Radius	17.00					

Physical Characteristics		Temperature Rating		Note
Volume V _e (mm ³)	Est. Weight (g)	Curie Temp:	500 °C	Cosmetic Standard: Magnetics Powder Core shapes criteria for appearance
17,900	95			

