

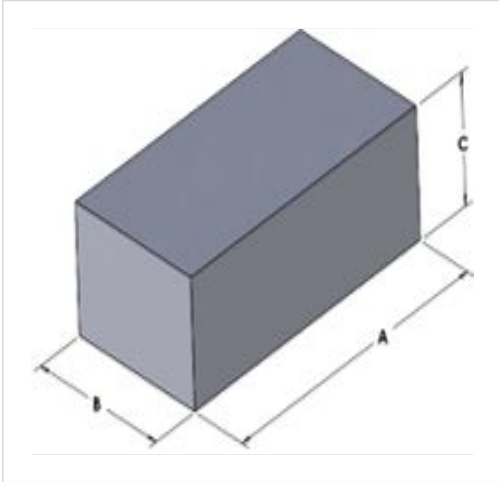

# 00H8020B060

110 Delta Drive  
 Pittsburgh, PA 15238  
 NAFTA Sales: (1)800-245-3984  
 HK Sales : (852)3102-9337  
 magnetics@spang.com  
 www.mag-inc.com



High Flux Permeability ( $\mu$ )	Core Marking	
	Lot Number	Part Number
60	XXXXXX	H8020B060

	Dimensions		Tolerance ( $\pm$ )		Packaging
	(mm)	(in)	(mm)	(in)	
A	80.50	3.168	0.50	0.020	Cardboard cut-outs Box Qty = TBD
B	20.30	0.799	0.50	0.020	
C	20.00	0.79	0.20	0.008	

Physical Characteristics		Temperature Rating	Note
Volume $V_e$ (mm <sup>3</sup> )	Est. Weight (g)	Curie Temp: 500 °C	Cosmetic Standard: Magnetics High Flux criteria for appearance
32,683	187.93		

