

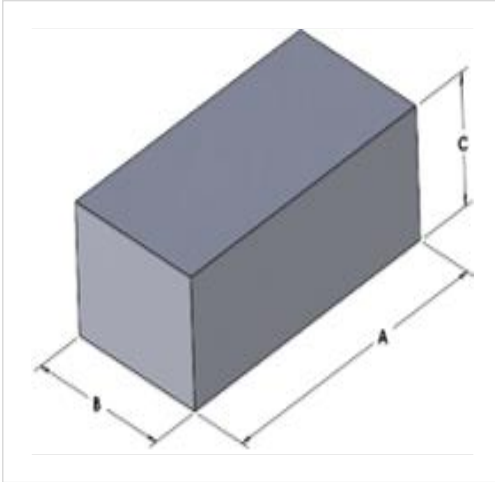

# 00F8020B060

110 Delta Drive  
 Pittsburgh, PA 15238  
 NAFTA Sales: (1)800-245-3984  
 HK Sales : (852)3102-9337  
 magnetics@spang.com  
 www.mag-inc.com



Kool M $\mu$ HF Permeability ( $\mu$ )	Core Marking	
	Lot Number	Part Number
60	XXXXXX	F8020B060

	Dimensions		Tolerance ( $\pm$ )			Packaging
	(mm)	(in)	(mm)	(in)		
A	80.50	3.168	0.50	0.020		Cardboard cut-outs Box Qty = TBD
B	20.30	0.799	0.50	0.020		
C	20.00	0.79	0.20	0.008		

Physical Characteristics		Temperature Rating	Note
Volume V <sub>e</sub> (mm <sup>3</sup> )	Est. Weight (g)	Curie Temp:	Cosmetic Standard: Magnetism Kool M $\mu$ HF criteria for appearance
32,683	187.93		

