

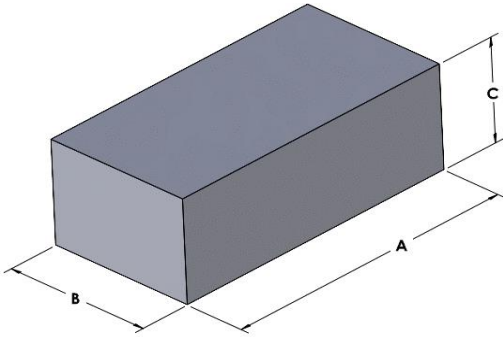

00F5030B040

110 Delta Drive
 Pittsburgh, PA 15238
 NAFTA Sales: (1)800-245-3984
 HK Sales : (852)3102-9337
 magnetics@spang.com
 www.mag-inc.com



Kool M μ Hf Permeability (μ)	Core Marking	
	Lot Number	Part Number
40	XXXXXX	F5030B040

	Dimensions		Tolerance (\pm)			Packaging
	(mm)	(in)	(mm)	(in)		
A	50.50	1.987	0.50	0.020		Cardboard cut-outs Box Qty = TBD
B	30.30	1.192	0.30	0.012		
C	15.00	0.590	0.20	0.008		

Physical Characteristics		Temperature Rating	Note
Volume V _e (mm ³)	Est. Weight (g)	Curie Temp: 700°C	Cosmetic Standard: Magnetics Kool M μ Hf criteria for appearance
23,000	133		

