

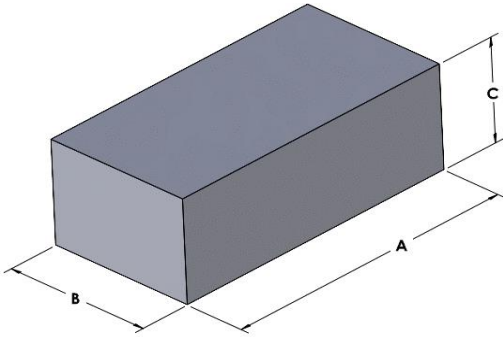

00A9541B026

110 Delta Drive
 Pittsburgh, PA 15238
 NAFTA Sales: (1)800-245-3984
 HK Sales : (852)3102-9337
 magnetics@spang.com
 www.mag-inc.com



Kool M μ Max A Permeability (μ)	Core Marking	
	Lot Number	Part Number
26	XXXXXX	A9541B026

	Dimensions		Tolerance (\pm)		Packaging
	(mm)	(in)	(mm)	(in)	
A	95.00	3.739	0.61	0.024	Cardboard cut-outs Box Qty = TBD
B	41.00	1.614	0.51	0.020	
C	27.51	1.083	0.41	0.016	

Physical Characteristics		Temperature Rating	Note
Volume V _e (mm ³)	Est. Weight (g)	Curie Temp: 700°C	Cosmetic Standard: Magnetism Kool M μ Max A criteria for appearance
107,200	621		

