

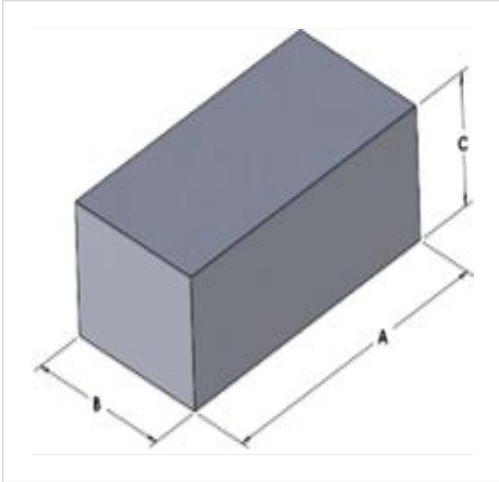

00A8020B040

110 Delta Drive
 Pittsburgh, PA 15238
 NAFTA Sales: (1)800-245-3984
 HK Sales : (852)3102-9337
 magnetics@spang.com
 www.mag-inc.com



Kool M μ Max Permeability (μ)	Core Marking	
	Lot Number	Part Number
40	XXXXXX	A8020B040

	Dimensions		Tolerance (\pm)		Packaging
	(mm)	(in)	(mm)	(in)	
A	80.50	3.168	0.50	0.020	Cardboard cut-outs Box Qty = TBD
B	20.30	0.799	0.50	0.020	
C	20.00	0.79	0.20	0.008	

Physical Characteristics		Temperature Rating	Note
Volume V _e (mm ³)	Est. Weight (g)	Curie Temp: 500 °C	Cosmetic Standard: Magnetism Kool M μ Max criteria for appearance
32,683	187.93		

