

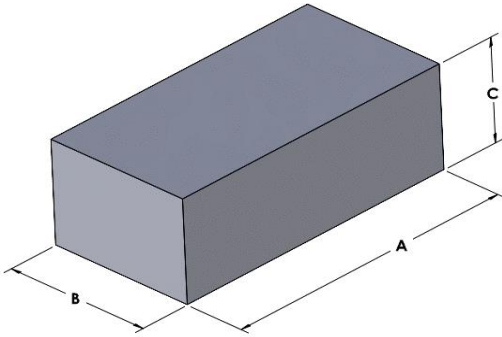

00A7030B060

110 Delta Drive
 Pittsburgh, PA 15238
 NAFTA Sales: (1)800-245-3984
 HK Sales : (852)3102-9337
 magnetics@spang.com
 www.mag-inc.com



Kool M μ Max A Permeability (μ)	Core Marking	
	Lot Number	Part Number
60	XXXXXX	A7030B060

	Dimensions		Tolerance (\pm)			Packaging
	(mm)	(in)	(mm)	(in)		
A	70.50	2.774	0.50	0.020		Cardboard cut-outs Box Qty = TBD
B	30.30	1.192	0.30	0.012		
C	20.00	0.787	0.20	0.008		

Physical Characteristics		Temperature Rating	Note
Volume V _e (mm ³)	Est. Weight (g)	Curie Temp: 700°C	Cosmetic Standard: Magnetics Kool M μ Max A criteria for appearance
42,800	256		

