

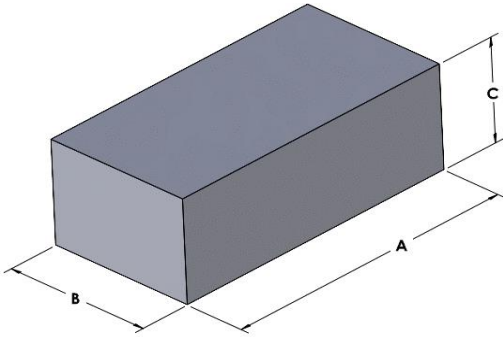

# 00A7020B040

110 Delta Drive  
 Pittsburgh, PA 15238  
 NAFTA Sales: (1)800-245-3984  
 HK Sales : (852)3102-9337  
 magnetics@spang.com  
 www.mag-inc.com



Kool M $\mu$ Max A Permeability ( $\mu$ )	Core Marking	
	Lot Number	Part Number
40	XXXXXX	A7020B040

	Dimensions		Tolerance ( $\pm$ )			Packaging
	(mm)	(in)	(mm)	(in)		
<b>A</b>	70.50	2.774	0.50	0.020		Cardboard cut-outs Box Qty = TBD
<b>B</b>	20.30	0.799	0.30	0.012		
<b>C</b>	20.00	0.787	0.20	0.008		

Physical Characteristics		Temperature Rating	Note
Volume V <sub>e</sub> (mm <sup>3</sup> )	Est. Weight (g)	Curie Temp: 700°C	Cosmetic Standard: Magnetics Kool M $\mu$ Max A criteria for appearance
28,600	172		

